

CP/M[®] VERSION 2.2.04 MANUAL

Volume I

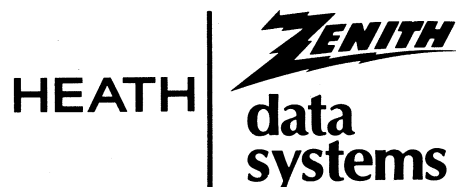

NOTICE

This software is licensed (not sold). It is licensed to sublicensees, including end-users, without either express or implied warranties of any kind on an "as is" basis.

The owner and distributors make no express or implied warranties to sublicensees, including end-users, with regard to this software, including merchantability, fitness for any purpose or non-infringement of patents, copyrights or other proprietary rights of others. Neither of them shall have any liability or responsibility to sublicensees, including end-users, for damages of any kind, including special, indirect or consequential damages, arising out of or resulting from any program, services or materials made available hereunder or the use or modification thereof.

This publication could contain technical inaccuracies or typographical errors. Changes are periodically made to the information herein; these changes will be incorporated in new editions of this publication.

Technical consultation is available for any problems you encounter in verifying the proper operation of this product. Sorry, but we are not able to evaluate or assist in the debugging of any programs you may develop. For technical assistance, write:

**Zenith Data Systems Corporation
Software Consultation
Hilltop Road
St. Joseph, Michigan 49085**

or call:

**(616) 982-3884 Application Software/SoftStuff Products
(616) 982-3860 Operating Systems/Languages/Utilities**

Consultation is available from 8:00 AM to 7:30 PM (Eastern Time Zone) on regular business days.

RESTRICTED RIGHTS LEGEND

Use, duplication, or disclosure by the Government is subject to restrictions as set forth in paragraph (b) (3) (B) of the Rights in Technical Data and Computer Software clause in DAR 7-104.9(a). Contractor/Manufacturer is Zenith Data Systems Corporation of Hilltop Road, St. Joseph, Michigan 49085.

Trademarks and Copyrights

**CP/M is a registered trademark of Digital Research Corporation
Digital Research is a trademark of Digital Research Corporation**

Copyright © 1983 by Zenith Data Systems Corporation.

**HEATH COMPANY
BENTON HARBOR, MICHIGAN 49022**

**ZENITH DATA SYSTEMS CORPORATION
ST. JOSEPH, MICHIGAN 49085**

IMPORTANT NOTICE

Dear Customer,

There have been some problems noted with the operation of the new CP/M update version 2.2.04. Please read the following information carefully.

SETUP

The SETUP disk works for most hardware configurations. It creates a bootable disk with proper BIOS according to your hardware environment including printers. It is important to read the displays and prompts carefully, because it is possible to erase a disk inadvertently left in a drive.

The SETUP disk will not work with a system containing a Z-67 Winchester drive. If your system contains a Z-67 Winchester drive it will be necessary for you to do a MAKEBIOS procedure (refer to page 1-94, "Customizing Procedures" of the Introductory Guide).

MAKEBIOS

In order to do a MAKEBIOS on a system containing only 5.25-inch drives (either hard-sectored or soft-sectored) it will be necessary to replace the MAKEBIOS.SUB file on Distribution Disk III with a new file. Using an Editor or Word-processor program create a new MAKEBIOS.SUB file containing the following:

```
$2:MAKEBIOS $2:1 $1:  
ASM BIOS.$2$1Z  
REN $1:BIOS.HX0=BIOS.HEX  
$2:MAKEBIOS $2:2 $1:  
ASM BIOS.$2$1Z  
REN $1:BIOS.HX1=BIOS.HEX  
$2:PREL $1:BIOS $1:  
$2:MAKEBIOS $1:3 $1:
```

Three disks are required in this MAKEBIOS procedure:

1. A duplicate of Distribution Disk I in drive A,
2. a duplicate of Distribution Disk III with the new MAKEBIOS.SUB file in place of the original MAKEBIOS.SUB file in drive B, and
3. a blank formatted disk in drive C.

Place the disks in the appropriate drives and boot up the system. At the system prompt enter:

```
SUBMIT B:MAKEBIOS C B
```

You must use both drive parameters (B and C). Do not use colons (:) after the drive parameters.

If your system has less than three drives you will be prompted to alternately insert different disks as the procedure progresses, as:

PUT DISK A IN DRIVE A: AND PRESS RETURN

or

PUT DISK B IN DRIVE A: AND PRESS RETURN

or

PUT DISK C IN DRIVE A: AND PRESS RETURN

Where "Disk A" is Distribution Disk I,
"Disk B" is Distribution Disk III, and
"Disk C" is the blank formatted disk.

When the procedure is complete the system prompt will be displayed.

Perform the rest of the procedures as listed in the "Customizing Procedures" section of the Introduction Guide.

Thank you,

ZENITH DATA SYSTEMS

Preface

CP/M® is an acronym for the Control Program for Microcomputers, the pioneer in the field of microcomputer operating systems. CP/M became instantly popular in the microcomputer field because of its convenience and wide range of practical applications.

This manual is designed to help you make CP/M productive and easy to use in your working environment. Heath and Zenith Data Systems have produced two volumes of CP/M documentation to provide instruction for CP/M users that have different levels of microcomputer experience:

- Volume I, "The CP/M Introductory Guide", provides an overview of CP/M and accompanying software, explanations of concepts for using CP/M with Heath/Zenith hardware, and step-by-step procedures for starting up and preparing your CP/M software.
- Volume II, "The CP/M Reference Guide", provides a comprehensive description of each command included in your CP/M software package.

If you are not familiar with CP/M practices and conventions, you will probably find it useful to read the overview and concept sections of Volume I first. Even individuals with no experience in computers will be able to understand and use CP/M by reading this first volume of the manual.

All users should perform the procedures in Volume I upon receipt of CP/M Distribution Disk media.

When you finish performing the necessary procedures in Volume I, you will be ready to use CP/M with the application program of your choice. But we urge you to make the most of your CP/M software package by exploring "The CP/M Reference Guide" in Volume II. This guide explains all about the many CP/M resident commands and transient commands.

This manual will be more effective if you read it while using your microcomputer. Test each concept on your microcomputer to reinforce your learning.

Table of Contents

Preface	V
---------------	---

VOLUME I: THE CP/M III INTRODUCTORY GUIDE

Section One — Beginning Concepts	1-1
Microcomputer Concepts	1-3
Disks	1-3
The Operating System	1-9
Application Programs	1-10
CP/M Concepts	1-12
Files	1-12
Disk Drives	1-15
Commands	1-19
 Section Two — Software Preparation Procedures	 1-27
Startup Procedures	1-29
Startup Procedure One	1-30
Startup Procedure Two	1-33
Startup Procedure Three	1-36
Startup Procedure Four	1-39
Unsuccessful Startup	1-42
Setup Procedure	1-43
Introduction	1-43
.....	1-45
Troubleshooting	1-48

Backup Procedures	1-52
Backup Procedure One	1-55
Backup Procedure Two	1-66
Backup Procedure Three	1-72
Backup Procedure Four	1-79
Backup Procedure Five	1-88
Customizing Procedures	1-94
Customizing Procedure One	1-96
Customizing Procedure Two	1-114
Customizing Procedure Three	1-132
Customizing Procedure Four	1-145
Customizing Procedure Five	1-169
Customizing Procedure Six	1-190
Working Disk Procedures	1-206
Working Disk Procedure One	1-208
Working Disk Procedure Two	1-209
Working Disk Procedure Three	1-210
Working Disk Procedure Four	1-211
Working Disk Procedure Five	1-212
Working Disk Procedure Six	1-213
System Copying Between Unlike Disks	1-214

VOLUME II: THE CP/M REFERENCE GUIDE
(Provided in a separate binder)

The CP/M Reference Guide	2-1
ASM: The Utility that Creates an Intel Hexadecimal File and a Printout File from an Assembly Language Program File	2-3
ASSIGN: The Utility that Assigns Winchester Disk Partitions to Drive Names	2-25
BRS: The Utility that Facilitates Backup of Winchester Disk Files to Floppy Disks	2-33
BSYSGEN: The Utility that Copies the Operating System Between Disks	2-79
CONFIGUR: The Utility that Customizes the CP/M Operating System for Several Characteristics of the Hardware Environment	2-87
DDT: The Dynamic Debugging Tool	2-119
DIR: The Resident Command that Displays Disk File Directories	2-145

DUMP: The Utility that Displays a File in Hexadecimal Form	2-149
DUP: The Utility that Duplicates and/or Verifies Entire Disks	2-151
ED: The Line Editing Utility that Creates and Edits Text Files	2-163
ERA: The Resident Command for Erasing Files	2-185
FORMAT: The Utility that Prepares the Disk Surface	2-189
LIST: The Utility that Prints File Contents on Paper	2-203
LOAD: The Utility that Loads a "HEX" File for Execution	2-211
MAKEBIOS: The Utility that Customizes the Operating System for Disk Drives	2-215
MOVCPMxx: The Utilities that Customize a CP/M Operating System Kernel to Fit Memory Size and Disk Type	2-221
PIP: The Utility that Copies Data Between Files, Disks, and/or Devices	2-227
PREL: The Utility that Creates a Relocatable File from Two Hexadecimal Output Files	2-247
REN: The Resident Command that Renames Files	2-251
SAVE: The Resident Command that Copies Data from Memory to a Disk File	2-253
SETLP: The Utility that Temporarily Sets Printer Characteristics	2-257
STAT: The Utility that Reports Disk Statistics and Assigns Types of Status	2-263
SUBMIT: The Utility that Triggers Automatic Execution of CP/M Commands	2-277
SYSGEN: The Utility that Puts the Operating System on a Disk	2-283
TYPE: The Resident Command that Displays File Contents on Console	2-289
USER: The Resident Command that Controls User Access to File Areas	2-291
XSUB: The Utility that Batches Commands Within Utility Programs for Automatic Processing	2-295

Appendices

Appendix A: Operating System Error Messages A-1

Appendix B: Recommended Hardware for
Heath/Zenith CP/M B-1

Appendix C: Bootstrap C-1

Appendix D: Basic Input/Output System
(BIOS) Organization D-1

Index

Section One

Beginning Concepts

This part of the manual explains concepts that are important when using the CP/M Operating System within your Heath/Zenith microcomputer environment.

The concepts explained here are grouped under the headings:

- “Microcomputer Concepts” Provided for individuals who have never before used microcomputers, and for individuals with limited microcomputer experience who wish to review.
- “CP/M Concepts” Provided for individuals who are new or unfamiliar with the CP/M Operating System.

Individuals who are proficient at using both microcomputers and CP/M can skip these parts of the manual, and proceed directly to the “Software Preparation Procedures”.

EXAMPLES OF USER/COMPUTER DIALOG

This text contains examples of user interaction with a microcomputer. In these examples, displays presented on the microcomputer terminal will be represented by the following typestyle:

THIS TYPESTYLE represents terminal displays

0123456789#\$*?: = . A > ()

User input (the characters that you type through the terminal) will be represented by boldface type, as shown:

BOLDFACE TYPE represents the things you type

0123456789#\$*?: = [.]()

Text that instructs you to press a key labelled with more than one character (such as the RETURN key or the CTRL key) will specify the label of this key in dark (boldface), slanted (italic), capitalized characters, as shown:

Press ***RETURN*** Hold down ***CTRL***

In many instances, the exact text of a display will vary by a few characters. This manual often substitutes a few letters in place of exact characters where variations are likely to occur. For instance, this manual will illustrate a program's serial number as "Serial number sss-sssss", while your terminal might actually display it as "Serial number 357-81469".

In cases where the exact characters you type will vary, this manual presents a description of the necessary characters within curved braces, {}.

Hence, this manual might explain that an entry should be made in the following form: **B = A:{filename.ext} *RETURN***, when you actually type the characters **B = A:CONFIGUR.COM *RETURN***.

Hardware device model numbers beginning with the "H/Z-" prefix are references to either a Heath device, a Zenith device, or both. For example "H/Z-89" in this manual refers to hardware devices that are labelled either "H-89" or "Z-89".

MICROCOMPUTER CONCEPTS

Your microcomputer is a sophisticated piece of equipment that reflects the latest technical advances in the computer field. But this machine is practically useless without the programs of instruction that tell it what to do.

These programs are stored on disks and used by your microcomputer when they are required to perform a task. This section explains how the programs are stored on disks, shows you how to handle your disks, and defines two important types of program: the operating system and the application program.

Disks

Stored information, or data, is arranged in concentric rings on the surface of a disk. These rings are called "tracks". Each track is divided into areas called "sectors". Each sector contains data measured in units called "bytes". A byte of data could be one letter typed at the terminal keyboard or one instruction in a program. But since a byte is such a small unit, you will more often see data measured in "kilobytes". A kilobyte (abbreviated as "k") is equal to 1024 bytes.

Data is transferred to disks in the form of magnetic impulses generated by an electromagnet called the "read-write head". As the name implies, the read-write head can read data from the disk or write data on the disk — similar to the way in which the head in a tape recorder transfers magnetic impulses to and from recording tape.

But unlike a tape recorder, a disk drive unit can transfer data at any location on the disk surface almost instantly, because the drive is usually spinning the disk at a high rate of speed. Whenever the read-write head is instructed to read or write data at a particular location on the disk, it positions itself along the appropriate track and skims across the surface of the disk as the appropriate sector spins by. Each disk has a directory that tells the read-write head which track and sector it should access to transfer the necessary information in the proper sequence.

There are two different kinds of tracks on every disk: system tracks and file tracks. System tracks are reserved for the disk's directory and for part of your operating system, and they are usually the two outermost tracks on the disk. File tracks are reserved for files, and they are the inner tracks on the disk. (Upcoming text will explain the concepts behind operating systems and files.)

NOTE: Before data can be written on a disk, the surface of the disk must be prepared. Disk preparation is performed by a program called "FORMAT", which is stored on your Distribution Disk (or Distribution Disk I). FORMAT prepares the disk surface by dividing it into tracks and sectors. The procedures for constructing backups and customizing the operating system will show you how to prepare disks using FORMAT.

Heath/Zenith offers disk drive units that will run the CP/M system with both floppy disks and Winchester Disks. Upcoming text deals with the unique aspects of each of these disk types.

FLOPPY DISKS

A floppy disk is a circular sheet of mylar plastic that is coated with a magnetic oxide and contained within a square plastic cover.

Floppy disks, and the data stored on them, are fragile. Therefore, you should adhere to the following precautions to ensure that disks and stored data are not damaged.

Floppy Disk Handling Precautions

- When holding the disk, touch only the protective square disk cover. Do not touch the brownish disk surface that shows through the read-write access slots in the disk cover.
- Keep disk in the protective paper envelope whenever it is not within a disk drive.
- Do not allow dust, ashes, liquid, or any other foreign material to contact the disk surface.
- Keep disk away from electric motors, appliances, telephones, etc., as these devices contain magnets that could alter the magnetic impressions on the disk.

- Never put a disk into a drive unit before turning on hardware equipment; and never leave a disk in a drive unit while the power is being turned off. Sudden fluctuations in the power supply to your hardware environment could cause the read-write head to “crash” against the disk surface, and destroy stored information.
- Do not expose disks to temperatures above 125 degrees Fahrenheit (52 Centigrade), or temperatures below 40 degrees Fahrenheit (10 Centigrade).
- Never press a ball-point pen or a pencil directly against the cover of a disk. Instead, mark disk labels before adhering them to the disk cover, or mark them using a felt-tip pen while they are on the disk cover.
- Do not allow the disk or its cover to be bent, creased, or torn.

Write Protecting and Write Enabling Floppy Disks

You can mechanically prevent or allow the writing or erasing of information to or from your disks by covering or uncovering the notch in the disk cover with specially-provided tabs. The way that you use these tabs depends on the size of the disk.

5.25-inch Disks

With 5.25-inch disks, the notch is covered to **prevent** you from writing to or erasing from the disk. Therefore by putting the tab on a 5.25-inch disk you are “write protecting” the disk. A 5.25-inch disk with a notch that is not covered can be written to or erased from. Therefore a 5.25-inch disk with an uncovered notch is “write enabled”. Figure 1-1 illustrates this distinction.

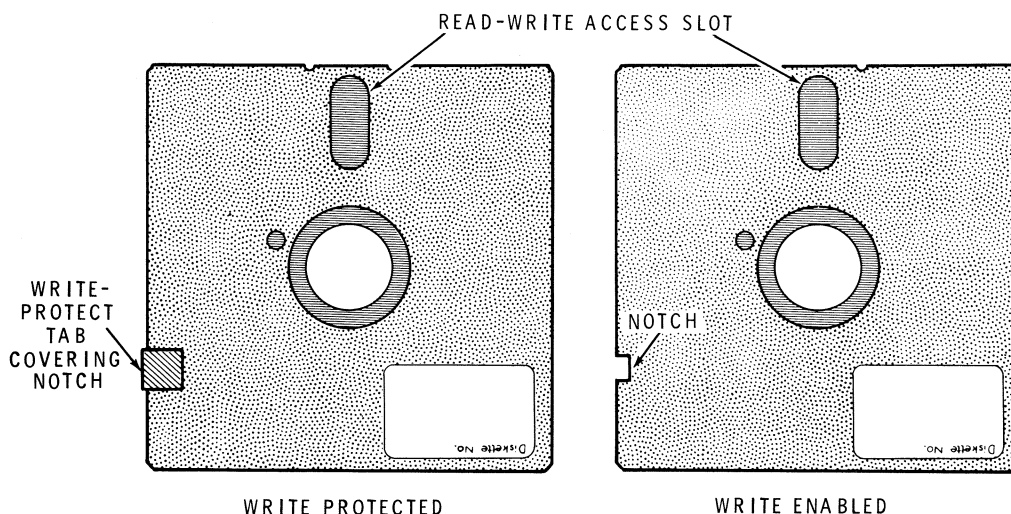

Figure 1-1
5.25-inch Floppy Disks

8-inch Disks

With 8-inch disks, the notch is covered to allow you to write to or erase from the disk. Therefore by putting the tab on an 8-inch disk you are "write enabling" the disk. An 8-inch disk with a notch that is not covered can not be written to or erased from. Therefore an 8-inch disk with an uncovered notch is "write protected". Figure 1-2 illustrates this distinction.

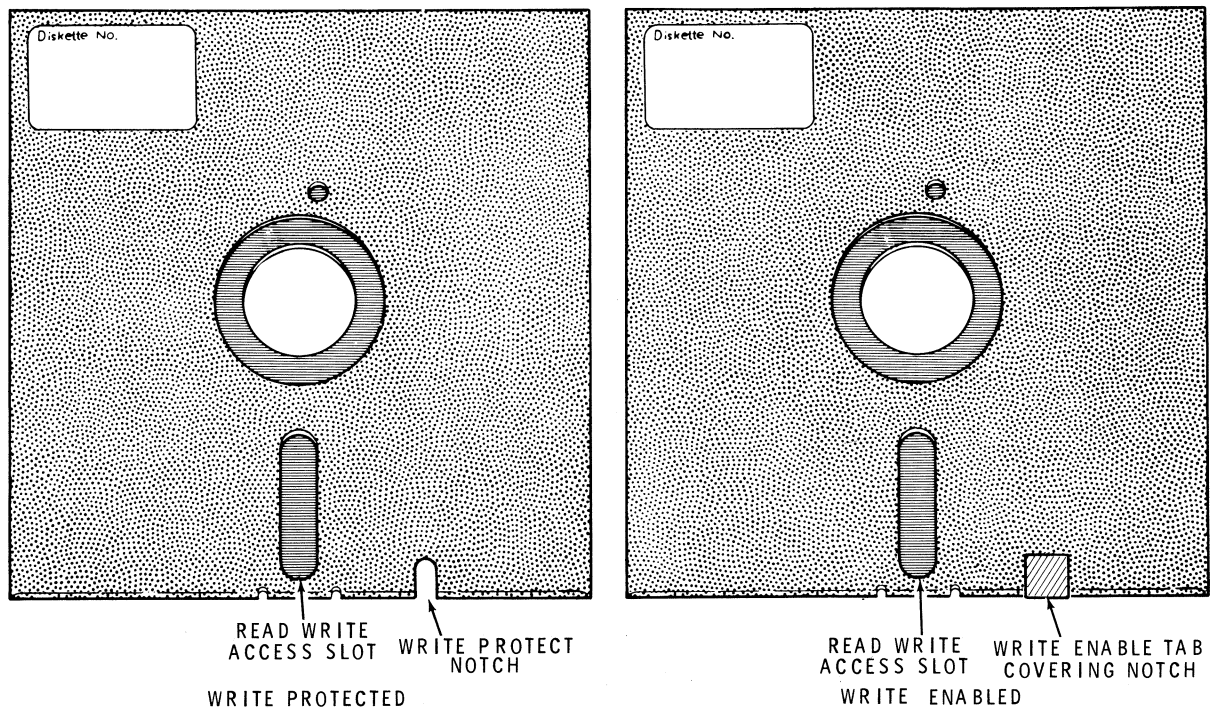

Figure 1-2
8-inch Floppy Disks

Eight-inch disks can also be mechanically write protected if you turn "on" a "write-protect" switch corresponding to each drive that contains a disk that you wish to protect. These switches are located on the front panel of the H/Z47 or H/Z67 disk drive models. You must always perform a warm boot after changing the setting of a write-protect switch. You can perform a warm boot by holding down the **CTRL** key and pressing the **C** key.

NOTE: Whether a disk is write protected or write enabled, you can read or copy data from it.

Inserting Floppy Disks

To insure that data stored on your floppy disks can be safely and efficiently accessed, the disks must be inserted into drives carefully and correctly.

When inserting a floppy disk into a disk drive, the read-write access slot in the square plastic cover should be pointing towards the back of the drive. A label is usually affixed to one side of the plastic disk cover, and this label should face upward or to the left as the disk is inserted into the drive. When the disk is fully inserted in the drive slot, close the drive door or fastening latch.

NOTE: For all floppy disk drive units, the power must be turned on **before** the disk is inserted. Floppy disks should **never** be within a drive when the power is off.

Figure 1-3 illustrates the proper technique for inserting floppy disks into some of the many drives that Heath/Zenith offers.

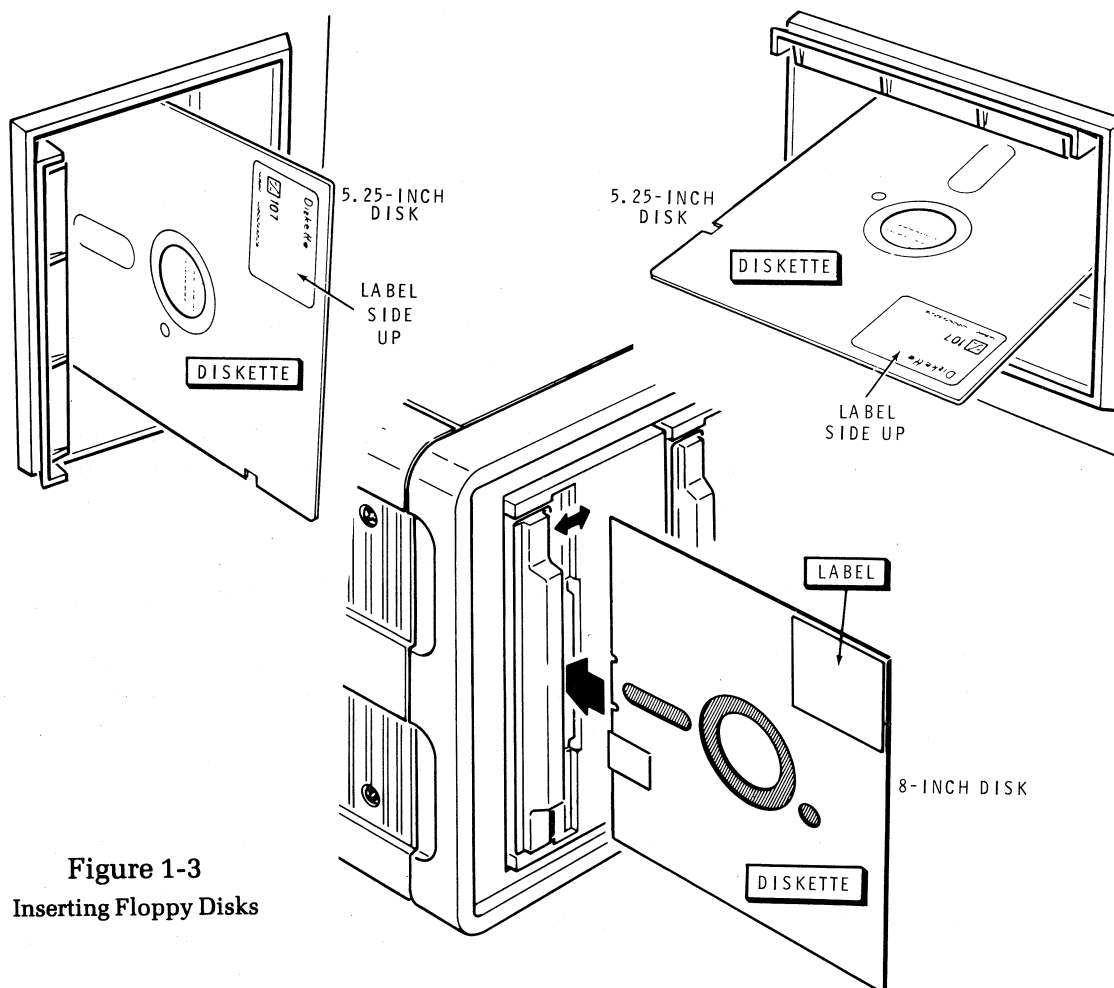

Figure 1-3
Inserting Floppy Disks

WINCHESTER DISKS

A Winchester Disk is a round metal plate with a coating of magnetic oxide on its surface. This disk is enclosed in the left-hand chamber of the H/Z-67 drive model.

Because the Winchester Disk has such a great capacity for stored data, it comes with a special program that allows you to establish separate data areas, called "partitions", on the disk. Winchester Disk partitions act as though they are separate disks. You can establish up to 62 distinct partitions on one Winchester Disk, and access them by using the AS-SIGN program stored on your CP/M Distribution Disk.

Since Winchester Disk partitions behave so much like disks, we will refer to them as "disks" throughout much of this manual.

NOTE: The H/Z-67 drive unit also contains a drive that accommodates 8-inch floppy disks. Information about such disks can be found in the text section dealing with "Floppy Disks".

Winchester Disk Precautions

Because the Winchester Disk stores so much information within such small surface areas, you should adhere to the following precautions to ensure that the disk and stored data are not damaged.

- Keep electric motors, appliances, telephones, etc. away from the H/Z-67 drive unit, as these devices contain magnets that could alter the magnetic impressions on the disk.
- Do not expose the H/Z-67 drive unit to temperatures above 125 degrees Fahrenheit (52 Centigrade), or temperatures below 40 degrees Fahrenheit (10 Centigrade).

Write Protecting and Write Enabling the Winchester Disk

The Winchester Disk can be mechanically set to prevent the writing or erasing of information to or from it, by turning "on" the left-hand "write-protect" switch (switch "0") on the front of the H/Z-67 drive unit.

NOTE: You must always perform a warm boot after changing the setting of this switch. You can perform a warm boot by holding down the **CTRL** key and pressing the **C** key.

The Operating System

An operating system is a computer program that controls both the components of your hardware environment and subordinate programs (“application programs”) that perform specific tasks.

It provides a vital link between your keyboard and your application programs, and between your application programs and your peripheral hardware. Thus it is essential that you use an operating system whenever you use an application program in your microcomputer environment.

The way that you use the CP/M Operating System is to copy an image of it (a “system image”) from a disk and put it inside the memory of your microcomputer. This activity (called “bootstrap”) is explained in the text entitled “Startup Procedures”.

CP/M can perform several useful functions when it is alone in your computer’s memory, but it also has “hollow” areas in which you can also store application programs as you need them.

OPERATING SYSTEM COMPONENTS

The Heath/Zenith CP/M operating system is divided into two software components: the “system kernel” and the file “BIOS.SYS”. A disk that contains both of these components can be said to contain the CP/M operating system. Such a disk can also be said to be “bootable”, which means that it contains an image of the operating system that can be inserted into the computer and used.

The System Kernel

The “system kernel” is a set of instruction programs that reside on the system tracks of a disk. These disk tracks are reserved for the system kernel and the disk’s directory. Special data transfer methods are necessary to move the system kernel from one disk to another. The system kernel helps to translate your keyboard entries into input that the computer can use.

The BIOS.SYS File

The “BIOS.SYS” file is a set of instruction programs that reside on any of the file tracks of the disk. BIOS.SYS can be manipulated by the same methods used to manipulate other files that are stored on

the disk. "BIOS" stands for Basic Input/Output System, which is the part of the operating system that enables CP/M to work with Heath/Zenith hardware.

Operating System Requirements

To use the operating system, you must transfer a copy of it from a disk to the computer by performing an activity called "bootstrap" or "bootup" or "cold booting". Both the system kernel and the BIOS.SYS file **must** be on a disk for that disk to be usable for bootup (the activity that puts CP/M in the computer) or for any other CP/M-related activities.

Furthermore most users must change, or "customize", both the system kernel and the BIOS.SYS file so that they will be compatible with the hardware devices that they must control. The text entitled "Customizing Procedures" will show you how to make the appropriate changes to a copy of the CP/M Operating System.

Application Programs

An application program is a set of instructions that tells your microcomputer how to perform a specific function.

Application programs are stored on the file tracks of a disks in units of data called files, (as explained in the "Files" text section). An application program might consist of several files that automatically access each other under certain circumstances. Whenever an application program file is needed to perform a specific task, an image of this file is copied from the disk and inserted into computer memory, where the CP/M Operating System has reserved "hollow" memory space for it.

After the application program files have served their purpose, CP/M moves them aside and either reserves its hollow memory areas for new application programs or executes some of the programs within the operating system itself.

EXAMPLES OF APPLICATION PROGRAMS

Your Distribution Disk contains several application programs which are often referred to as "transient commands" or "utilities". These programs are stored on the Distribution Disk, and are identified by names

that end with the file extension "COM". This extension indicates that these files are valid COMmands, that can execute under CP/M.

The following list shows just some of the other kinds of application programs that can perform specific tasks when controlled by the CP/M Operating System.

BUSINESS:

Electronic Spread Sheet
 Inventory Management
 General Ledger
 Accounts Receivable
 Accounts Payable
 Sales Invoicing
 Payroll
 Client Posting & Accounting
 Property Management
 Word Processing
 Mail List Management
 Electronic Dictionary
 Data Base Management
 Automatic Letter Generator

PROGRAMMING LANGUAGES:

BASIC-80 Interpreter
 BASIC-80 Compiler
 C-BASIC
 FORTRAN-80
 COBOL-80

SYSTEM UTILITIES

Macro Assembler
 Printer Spooler
 Symbolic Debugger

APPLICATION PROGRAM REQUIREMENTS

It is important to remember that an application program cannot produce the results you desire without the presence of an operating system. Therefore, you must always load the CP/M operating system into your microcomputer before you can use any application program. (The text entitled "Startup Procedures" will show you how to put CP/M in your computer.)

Furthermore, an application program cannot use all of the devices in your hardware environment unless the CP/M Operating System that controls it has been customized to work with your hardware. (The Customizing Procedures will show you how to customize CP/M.)

CP/M CONCEPTS

This text section explains some of the basic properties of the CP/M Operating System and some of the conventions you must follow when using the system. After reading Microcomputer Concepts and this section, you should be ready to perform the Software Preparation Procedures.

Specifically, this section shows you how CP/M stores data in units called files, how CP/M accesses these files through disk drives, and how you should issue commands to the CP/M Operating System.

Files

The CP/M Operating System enables you to create, analyze, and manipulate data by storing this data in units called "files". These files are stored on the surface of a disk and given a name that conforms to CP/M file naming conventions.

When you issue a command that refers to a particular file by name, CP/M goes to the appropriate disk, makes a copy of the file, and puts the copy into one of the hollow memory areas inside the computer.

CP/M FILE NAMING CONVENTIONS

A file name consists of two parts: the primary name and the extension. The primary name has between one and eight characters, and is essential in all file names. The extension can have between one and three characters, or it can be omitted entirely. The primary name and the extension are separated by a period (.), in the following form:

{primary name}.{extension}

The characters used in the primary name and extension can be any character on the console keyboard except the following special characters:

<>.,;: =?*[]

The following example file names all conform to these conventions:

FORMAT.COM memo.doc BIOS.SYS 4/27/81.TXT

JOB3.HEX FILE#1 33%-RATE.DAT WSMMSG.S.OVR

Although the extension is optional, you'll probably find it useful to give your files extensions that somehow describe the type or purpose of the file you are naming. The following list shows several extensions that are applied to files used for a specific purpose:

EXTENSION	FILE PURPOSE
COM	Command binary file (executable under CP/M)
ASM	Assembler source file
HEX	Intel HEX object file
PRN	Print file of program listing
BAS	BASIC source file
INT	Intermediate BASIC file (for BASIC-E, C-BASIC)
BAK	Backup file from prior edit
LIB	Library source file
SUB	A list of commands to be executed with SUBMIT
\$\$\$	Temporary work file
FOR	FORTRAN source file
DAT	ASCII data file
DOC	ASCII document file

REFERENCING SEVERAL FILES AT ONCE (WILDCARD FILE NAMES)

Many of the commands that you will issue refer to files by name. But when you want to issue the same command for several files with similar names, it is often more convenient to enter a "wildcard file name" with the command.

A "wildcard file name" represents several file names — much like a "joker" in a deck of cards can stand for any card in the deck. (Wildcard file names are sometimes called "ambiguous file names".) A wildcard file name contains either asterisks (*), or question marks (?), or both.

An asterisk (*) is entered in place of the entire primary name and/or extension of a file, as shown in the following example:

16MAY82.*

In this example, the asterisk replaces the extension so that this wildcard refers to files on the disk with the primary name "16MAY82" and **any** extension.

In the following example, the wildcard asterisk takes the place of the primary name:

*.COM

Therefore, all files with the extension "COM" and **any** primary name would be referenced.

The wildcard "*. *" stands for **any** file on the disk. (Actually, there are exceptional circumstances under which all of the files on a disk cannot be referenced at one time, but these circumstances will be explained in later text.)

Question marks (?) can be used in a wildcard file name to take the place of single characters at fixed file name positions. For instance, the wildcard file name

JOB?.HEX

would refer to any file that has the extension "HEX" a primary name with the characters "J", "O", "B", and one or fewer additional characters. Hence the files "JOB0.HEX", "JOB1.HEX", "JOBY.HEX", and "JOB.HEX" are just a few of the files that could be referenced by such a wildcard (if these files existed on the disk).

You can use any number of question marks in a wildcard (up to 11) and the actual file names referenced will be those with the same characters as those that are explicitly stated in the wildcard and any characters in the place of the question mark characters.

Thus the wildcard "?????????.COM" will reference any file on the disk with the "COM" extension — just like the "*.COM" wildcard.

Disk Drives

A disk drive is a device that transfers data to and from disk storage media — whether that media is on a floppy disk or on a Winchester Disk partition. (Since floppy disks and Winchester Disk partitions are so similar in function, this text will refer to both as “disks” in most cases.)

DRIVE NAMES

To allow you to refer to disks and files within your disk drives, the CP/M Operating System recognizes each drive in your hardware environment by a distinct “drive name”. A drive name consists of a letter of the alphabet in the range “A” through “F”, and a colon (:).

Possible drive names are “A:”, “B:”, “C:”, “D:”, “E:”, and “F:”.

DEFAULT DRIVE

The drive from which you perform bootstrap is always referred to as “default drive A:”, as indicated by the “A>” system prompt that your console displays when the CP/M image is inside the computer. The default drive is the drive to which the system will refer, unless you specifically tell the system to refer to a different drive.

You can execute an application program that is stored as a file in the default drive by typing the **primary** file name of the application program file (the part without the “COM” extension) in response to the system prompt, as shown:

```
A>{primary name}
```

Where “A>” is the default drive prompt (or system prompt); and

where **{primary name}** is the primary name of the file that you want to execute. For this command to be valid, the file must reside on a disk in default drive A:, and have a “COM” extension.

If the Application Program file represented by **{primary name}** does not reside on default drive A:, then the system will display a message repeating your unfound entry with a question mark, as shown:

```
A>{primary name}
{primary name}?
```

This kind of error message will also occur if you use improper syntax in your entry or misspell your entry.

Changing the Default Drive

You can change the default drive by typing the name of another drive and a carriage return at the "A>" prompt, as shown:

```
A>B: RETURN
```

Such an entry will produce a new system prompt, indicating that drive B: is now the default drive, as shown:

```
A>B: RETURN  
B>
```

NOTE: Any drive that is changed to the default drive in this fashion must be a valid drive within your hardware environment, and it must contain a floppy disk prepared by the FORMAT program or a Winchester Disk partition prepared by both the FORMAT and ASSIGN programs.

You can experiment with changing default drives by entering drive names (with a carriage return) one at a time at the system prompt. When you switch default drives in this fashion, the CP/M system will assume that any Application Program you wish to execute should be found on a disk in the new default drive. This experiment is a good way to determine the names of your drives if you're not sure.

Accessing a Nondefault Drive (Logging In)

A "nondefault drive" is a disk drive whose name is not displayed in the system prompt. For instance, if the "A>" system prompt is displayed (meaning A: is the default drive), then your nondefault drives are any valid drives with names "B:" through "F:".

When you want to execute an application program that resides in a disk file in a nondefault drive, type the name of the appropriate nondefault drive immediately before typing the program's primary name and a carriage return:

```
A>B:{primary name} RETURN
```

Where "A>" is the default drive prompt (or system prompt);
where **B:** is the name of the desired nondefault drive; and
where **{primary name}** is the primary name of the file that you want to execute. The file must reside on a disk in nondefault drive B:, and have a "COM" extension.

The CP/M system would respond to such an entry by "logging in" disk B: to get the application program file indicated by **{primary name}**, inserting an image of this program into computer memory, and executing the program.

NOTE: If you try to reference a drive that does not exist in your hardware environment or a drive that does not contain a disk (by logging in, or switching default status), then the system will look for the referenced disk drive indefinitely. Meanwhile, the system will accept no other commands unless you reset the computer and perform a cold boot.

SWITCHING FLOPPY DISKS BETWEEN DRIVES

When you reference a floppy disk drive (by entering a command at a default drive, by changing default drives or by logging in a nondefault drive with a command), the CP/M system remembers some of the characteristics of the disks in the referenced drives. Switching disks between drives can cause problems unless you tell the system to forget the old disks.

You can make the system forget about old disk characteristics by performing a "warm boot". You can perform a warm boot by holding down the CTRL key and pressing the C key. This entry is often abbreviated as **CTRL-C**. This entry is usually entered in response to the "A>" system prompt. It tells the operating system to forget what it knew about the disks that used to be in the drives and to redisplay the system prompt.

We suggest that you perform a warm boot whenever you remove a disk from a drive and replace it with another disk (unless the system prompts you to insert a different disk).

NOTE: If you perform a warm boot during the execution of some application programs, execution of this program might end, whereupon control would return to CP/M.

FOR USERS WITH ONE OR TWO 5.25-INCH DRIVES

A hardware environment with one or two 5.25-inch drive slots appears to have just that many drives. But under the CP/M Operating System, such a disk drive environment enables you to perform most of the activities you could perform with three drives.

CP/M actually believes that you have three disk drives. The three drives that CP/M believes you have are called "logical" drives. The drives that you can actually see in front of you are called "physical" drives.

When you enter a command that requires more disks than you have physical drives, CP/M displays prompts that instruct you to insert the required disks at the appropriate time.

The prompts will appear in the form:

```
PUT DISK B IN DRIVE A: AND PRESS RETURN
```

When such a prompt appears, you should remove the disk that is already in the drive, insert the disk that the prompt indicates, and enter a carriage return. Execution of the program will resume until data from a different disk is needed. Then a similar prompt will appear, requesting that you insert a different disk.

When switching disks between a drive in this manner, you do not have to perform a warm boot after a disk switch. However, you must keep track of which disk is which. If you insert the wrong disk, you might have to start the activity over.

Procedures for constructing backup disks and customizing the operating system contain instructions for putting this "logical/physical drive" concept to work.

NOTE: CP/M's logical/physical drive feature enables you to use many utilities that transfer, change, or create data amongst two or three disks in a single activity. However, the DUP utility cannot be used at all unless your number of physical drives matches the number of disks required for the DUP activity.

Commands

In general, a command is a program that can help you to create, change, analyze, or move data. Commands are entered in response to a “system prompt”.

A system prompt consists of the letter for the default drive and the greater-than (>) character. When you start up CP/M, the system prompt is displayed on your console, as shown:

```
A>
```

The system prompt tells you that CP/M is ready to receive a command in the form of a “command line”.

COMMAND LINES

A command line is the form of response you make to the system prompt to bring up, or “invoke”, a command. A command line usually consist of three components: the “function”, the “argument”, and the “carriage return”. The function is entered first, and it indicates the activity that will be performed. The argument is entered one space after the function. The argument indicates what data (files, systems, disks, drives, etc.) the function’s activity should be performed upon. After entering the function and argument, you must enter a carriage return to tell CP/M that the entire command line is ready for execution.

You will enter command lines in the following form:

```
A>{function} {argument} RETURN
```

Where “A>” is the system prompt;

where {function} is mandatory for all commands;

where {argument} is optional for some commands; and

where *RETURN* is mandatory for all commands.

Always separate the command line function and the command line argument with one space. Furthermore, any command entered at a prompt with the “>” character must end with a carriage return. However, commands themselves often display prompts as well. When such

a prompt ends with a colon (:), a carriage return is not required in your response.

NOTE: In this text, the entry of a carriage return will often be illustrated in the form **RETURN**.

There are two kinds of commands that can be executed in a CP/M operating environment: Resident Commands and Transient Commands.

RESIDENT COMMANDS

Resident Commands reside within the CP/M operating system. Therefore, CP/M doesn't have to refer to a disk to know how to execute these commands — although the commands themselves might affect data that is on a disk.

The CP/M Operating System contains the following resident commands:

DIR	Displays the names of files that reside on a disk.
ERA	Erases specified files from a disk.
REN	Renames a specified file on a disk.
SAVE	Saves the contents of computer memory space by creating a file on a disk.
TYPE	Displays the contents of a file on the terminal.
USER	Enables you to divide the space on a disk into separate areas for different users.

This list shows only the command line function of the resident commands. See Volume II: "The CP/M Reference Guide" for a comprehensive explanation of the arguments used when these commands are entered.

TRANSIENT COMMANDS

Transient commands are application programs that are supplied with the CP/M Operating System on your Distribution Disks. These application programs help you to manipulate the operating system and to perform several other useful microcomputer activities.

These commands (also known as “utilities”) are stored on the disk as files with the “COM” extension. When you issue a command that makes reference to one of these files, CP/M takes an image of this file from the appropriate disk, inserts this image into one of CP/M’s hollow areas inside computer memory, and begins execution of the transient command.

The following list shows the files containing all of the transient commands offered on Heath/Zenith CP/M distribution disk media.

ASM.COM	MAKEBIOS.COM
ASSIGN.COM	MOVCPM17.COM
BRS.COM	MOVCPM37.COM
BSYSGEN.COM	MOVCPM47.COM
CONFIGUR.COM	MOVCPM67.COM
DDT.COM	PIP.COM
DUMP.COM	PREL.COM
DUP.COM	SETLP.COM
ED.COM	STAT.COM
FORMAT.COM	SUBMIT.COM
LIST.COM	SYSGEN.COM
LOAD.COM	XSUB.COM

To use a transient command in a command line, you type the primary file name of the file that contains this command. This primary name is the command line function.

Due to the complexity of the activities that these commands perform, some require special files for their command line arguments. The following list shows some of the argument files required by some transient commands:

DUMP.ASM	BIOS.ASM	MAKEBIOS.SUB
----------	----------	--------------

The procedures for making backup disks, customizing the operating system, and making working disks contain step-by-step instructions for entering transient command lines.

Volume II: “The CP/M Reference Guide” supplies further details on all aspects of these commands.

COMMAND LINE ENTRY

The CP/M Operating System is very precise in the way it accepts command lines. You must spell all components of a command line correctly and include the names of nondefault disks drives whenever a referenced file is not on the default disk. If you don't, CP/M will not be able to execute your command and will respond by redisplaying the invalid command line with a question mark (?).

However, CP/M does allow some flexibility in the way you may respond to the system prompt. CP/M performs special functions when you type any of the special entries that are explained below.

NOTE: In this text, "CTRL" followed by a hyphen and a letter indicates that you should hold down the key marked "CTRL" (control key) and then press the key of the specified character.

The following list explains the single keys and combinations of keys that you can press to edit a command line before submitting it to CP/M for execution.

DELETE Removes the previous character typed from the command line. Depending on how your Operating System is adjusted, the removed characters might be echoed (repeated in reverse) on the video console display, or erased from the display.

DEL Removes the previous character typed from the command line. Depending on how your Operating System is adjusted, the removed characters might be echoed (repeated in reverse) on the printed console display.

BACK SPACE Removes the previous typed character. Also removes any "DELETED" characters that were echoed in the line.

CTRL-H Same as "BACK SPACE".

CTRL-X Removes all characters typed in the command line, as if you used "BACK SPACE" all the way to the beginning of the line.

CTRL-U Effectively removes all characters typed in the command line, and allows you to try again on the line beneath the old line. It leaves the display of the old command line on

the console, and displays the “#” character at the end of this old line to label it as a nullified entry.

CTRL-R Redisplays the edited version of a command line below the “scratch pad” version of the line without any of the “DELETED” characters that might have been echoed in the line. Also displays the “#” character at the end of the “scratch pad” version.

The following list explains the single keys and combinations of keys that you can press to end a command line and submit it to CP/M for execution.

RETURN Ends the command line, sends the command to the system for execution, and displays nothing on console. After execution of the command, CP/M redisplay a system prompt. In this manual, you will be instructed to press this key in the form **RETURN**.

CTRL-J Same as “RETURN”.

CTRL-M Same as “RETURN”.

The following list explains the single keys and combinations of keys that you can press to change the way in which CP/M executes your command line:

CTRL-S Interrupts the display of data to the console when pressed once. Allows CP/M to resume data display when pressed a second time. This entry is useful when data scrolls by on a console too quickly for you to read it. Part III: Reference Guide explains the commands during which it is safe and useful to make this entry.

CTRL-P Causes CP/M to send everything it displays on the console device to the list device (LST:) at the same time. (The list device is usually a printer or a modem.) Making this entry a second time will stop the display to the list device. This entry is useful when you want to record the displays that appear during the execution of a command on paper, or send them through the telephone.

The routing of console displays to the list device will continue during and after the execution of any resident command or transient commands STAT, DUMP, and CONFIGUR. This data routing will remain in effect during (not after) the execution of any other transient command except SUBMIT, XSUB, and MAKEBIOS. However, this entry will not cause data routing to the list device during the execution of most other application programs.

If you type a CTRL-P entry while your list device is disconnected, turned off, in a local mode, or off line, then your system might try to route data through the inactive list device indefinitely, and refuse to accept commands until you reset and perform a cold boot.

The following entry enables you to enter an unusually long command line:

CTRL-E Enables you to see the entire display of a command line that is longer than your screen or platen is wide. When you type this entry, the remaining portion of your command line will be displayed at the left-hand end of the screen or platen, below the beginning portion of the command line.

This entry will not send your command line to the system for execution (as a "RETURN" entry would). It is not essential that you enter CTRL-E when typing a command line that exceeds console display range, because CP/M will process your command line even if you cannot see the whole line.

Even if you type CTRL-E entries, no command line can exceed 127 valid characters in length. If you type a 128th character in a command line, CP/M will automatically interpret it as a carriage return and try to execute the first 127 characters as a command.

The following entries enable you to enter comments that CP/M will ignore:

;

(The semicolon.) Enables you to enter comments not intended for execution without receiving error feedback from CP/M. To cause CP/M to ignore a comment, you must make the ";" the first character entered at the system prompt.

Comments can consist of any characters you wish, typed after the “;” entry, and followed by a “RETURN” or “CTRL-U” or “CTRL-X”.

: (The colon) Same as “;” (semicolon).

The following entries enable you to rapidly skip several spaces in a command line or comment:

TAB As with a regular typewriter, this key enables you to advance several spaces without pressing the space bar several times. It skips to the eighth column of the console display range or to some column numbered by a multiple of eight. Hence if you enter a TAB at the beginning of a command line, you will skip six columns (because the system prompt takes up two columns). If you immediately enter another TAB, you will skip eight columns, and so forth.

CTRL-I Same as “TAB”.

Section Two

Software Preparation Procedures

This part of the manual provides five kinds of procedures that will help you prepare your CP/M software so that it works efficiently with your hardware:

- “Startup Procedures” help you to prepare your microcomputer hardware for use, and to load the CP/M Operating System into your microcomputer.
- “Setup Procedure” helps users of most Heath/Zenith hardware environments to copy CP/M distribution software and to make system disks. With proper hardware, Setup can be used instead of Backup Procedures and Customizing Procedures and Working Disk Procedures.
- “Backup Procedures” help you to copy your CP/M distribution software to backup disks, to protect your software investment.
- “Customizing Procedures” help you to adjust the CP/M Operating System so that it controls your hardware environment.
- “Working Disk Procedures” help you to combine useful application programs on a customized bootable disk.

Each procedure begins with a key or table to help you determine which section of the procedure you should use, based on the kind of hardware you have.

EXAMPLES OF USER/COMPUTER DIALOG

This text contains examples of user interaction with a microcomputer. In these examples, displays presented on the microcomputer terminal will be represented by the following typestyle:

THIS TYPESTYLE represents terminal displays

0123456789#\$*?: = . A> ()

User input (the characters that you type through the terminal) will be represented by boldface type, as shown:

BOLDFACE TYPE represents the things you type

0123456789#\$*?: = [.]()

Text that instructs you to press a key labelled with more than one character (such as the RETURN key or the CTRL key) will specify the label of this key in dark (boldface), slanted (italic), capitalized characters, as with ***RETURN*** and ***CTRL***.

In many instances, the exact text of a display will vary by a few characters. This manual often substitutes a few letters in place of exact characters where variations are likely to occur. For instance, this manual will illustrate a program's serial number as "Serial number sss-sssss", while your terminal might actually display it as "Serial number 357-81469".

In cases where the exact characters you type will vary, this manual presents a description of the necessary characters within curved braces, { }. Hence, this manual might explain that an entry should be made in the following form: **B: = A:{filename.ext} RETURN**, when you actually type the characters **B: = A:CONFIGUR.COM RETURN**.

Hardware device model numbers beginning with the "H/Z-" prefix are references to either a Heath device, a Zenith device, or both. For example "H/Z-89" in this manual refers to hardware devices that are labelled either "H-89" or "Z-89".

If you have trouble performing a procedure or if you obtain an error message, then refer to Volume II: "The CP/M Reference Guide". The reference guide contains comprehensive explanations of each utility. If you encounter an error message that is not explained in the reference guide, then consult Appendix A: "Operating System Error Messages".

STARTUP PROCEDURES

This section will explain the sequence of steps necessary for starting up a session of CP/M use. This sequence includes the preparation of your hardware devices, the insertion of a bootable disk into the appropriate drive, and the movement of a copy of the CP/M operating system from a disk into your microcomputer's memory.

The most significant step in this sequence is the movement of CP/M from a disk into the microcomputer. This step is known as "bootstrap" or "booting up" or "cold boot". You will perform this step at least once, each time you use CP/M in your microcomputer. Once inside your microcomputer, CP/M can control an application program or perform one of the many tasks within its own repertoire.

The startup procedure you should use is determined by the type of microcomputer you have.

If you have an H/Z-88, H/Z-89, or H/Z-90 microcomputer, then you should use "Startup Procedure One".

If you have an H-8 microcomputer without special options, then you should use "Startup Procedure Two".

If you have an H-8 microcomputer with the PAM-8 Panel Monitor Program, use "Startup Procedure Three".

If you have an H-8 microcomputer with the HA8-8 Extended Configuration Board, use "Startup Procedure Four".

These procedures show you how to boot up using only the first drive of your primary drive group. These procedures also assume that your distribution software is recorded on disks that can be used in the first drive of your primary drive group.

If your distribution software is not recorded on disks that can be used in the first drive of your primary drive group, then you will need to enter a different bootup command than the one advised in your startup procedure or change a switch setting within your computer. Refer to Appendix C: "Bootstrap" for instructions on different bootup commands or switch settings.

NOTE: The CP/M Operating System recorded on your distribution media is preset to work with a terminal that has a baud rate of 9600. The H/Z-88, H/Z-89, and H/Z-90 microcomputers contain terminals with a 9600 baud rate. However, some printing terminals that can be used with the H-8 microcomputer have baud rates other than 9600, which will not allow you to perform a startup procedure until the baud rate of your CP/M system has been changed to match that of your terminal.

Therefore, if you are using a printing terminal with a baud rate other than 9600 (such as a Decwriter or Diablo KSR 1640), you will first need to customize your CP/M system using a different terminal that does have a baud rate of 9600.

Startup Procedure One

H/Z-88, H/Z-89, or H/Z-90 Microcomputer

This procedure consists of five steps to help you start up the CP/M Operating System in your H/Z-88, H/Z-89, or H/Z-90 microcomputer.

1. Connect and power up **all** of your hardware devices.

Refer to the manuals for each device to be sure that it is properly connected and turned on. In general, all of the “on-off” switches should be in the “on” position. When turned on, your microcomputer should display the following message in the upper left-hand corner of the display screen:

H:

2. If this display does not appear after you turn the computer on (allowing time for the screen to warm up), then hold down the **SHIFT** key and press the **RESET** keys. This entry resets your microcomputer.
3. Insert your CP/M Distribution Disk (or Distribution Disk I or the Setup Utility Disk or a different bootable disk) into your primary boot drive. You can determine which drive is your primary boot drive by the following guidelines:
 - If you have a 5.25-inch drive mounted beside your display screen, insert the disk into this drive.

- If you have an H/Z-37, H/Z-47, H/Z-77, H/Z-87, or H/Z-17-3 drive model and no drive mounted beside the display screen, insert the disk into the drive slot on the left-hand side of the drive model.
 - If you have more than one type of disk drive, insert the disk into the left-hand slot of the drive model that accommodates your Distribution Disk.
 - If you have an H/Z-67 Winchester Disk drive model which does not yet contain the operating system, insert the Distribution Disk into the 8-inch floppy disk drive slot on the right-hand side of the H/Z-67 drive model.
 - If you have an H/Z-67 drive model in which the Winchester Disk already contains a copy of the operating system, insert nothing and proceed to step 4.
4. Respond to the "H:" prompt by typing the bootstrap command **B** and entering a carriage return at the terminal keyboard. The computer will automatically complete your command by displaying the remaining characters in the word "Boot", as shown:

H: **B**oot

This entry should complete a successful bootstrap (or cold boot), which loads a copy of the CP/M Operating System from your Distribution Disk into your microcomputer.

When you have performed a successful bootstrap (cold boot), the light on disk drive A: will glow to indicate that the disk drive is reading the CP/M Operating System from the disk and sending a copy of it into microcomputer memory. (If drive A: is a Winchester Disk partition, no light will glow.) When this CP/M system copy enters the microcomputer, it identifies itself by displaying a message in one of the following forms:

```
nnK HEATH/ZENITH CP/M 2.2.04 09/15/82
FOR Hdd DISKS WITH OPTION(S) cccc
```

Where "nn" is the number of K (kilobytes) of data CP/M is capable of handling now. Make note of this number for future reference;

where "2.2.04" is the version number of your CP/M system. Make note of this version number for future reference;

where "dd" is a number that stands for the kind of disk drives that this CP/M image is capable of controlling now; and

where "cccc" is a group of letters and or numbers that stand for some of the characteristics of this CP/M image.

After identifying itself, CP/M will automatically invoke the "Heath/Zenith Configuration Program", which will display further messages.

NOTE: When you boot up with a CP/M disk other than your Distribution Disk, CP/M might not automatically invoke the "Configuration Program", but instead display the "A>" system prompt immediately after the CP/M identification message. If you boot up with the Setup Utility Disk, Setup displays will appear instead of CP/M messages or a system prompt.

If you are booting up to a new CP/M Distribution Disk, or a new CP/M Backup Disk operating system copy that has not yet been completely customized, then the CP/M identification message may be automatically followed by several additional messages, displayed in the following form:

```
Heath/Zenith Configuration Program
Version 2.2.04
Serial number sss-sssss
```

```
This program configures the CP/M operating system to a
particular hardware environment
```

```
Please wait during hardware verification. . .
```

```
H/Z89 with 48k of random access memory (RAM)
03 minifloppy drives
H/Z47 8 inch floppy disk interface
CRT baud rate is 9600
02 additional serial ports found
```

```
Drive A disk is write protected.
Modifications will NOT be made to the disk for this CONFIGUR run.
```

```
Standard system (Y or N) <Y>:
```

The "Configuration Program" that CP/M invoked automatically is the transient command (utility) called "CONFIGUR". When invoked, CONFIGUR automatically surveys characteristics of some of the devices in your hardware environment so that CP/M can recognize and control these devices.

5. The "Standard system" prompt can enable you to access the CP/M Operating System immediately if you enter Y. If you enter Y, CP/M will display the "A>" system prompt.

NOTE: If you are booting up as part of a procedure, read the instructions of this procedure to determine whether or not it would be desirable for you to enter Y at this prompt.

Bootstrap will be a frequent activity in future procedures.

Startup Procedure Two

H-8 Microcomputer

This procedure consists of six steps to help you start up the CP/M Operating System in your H-8 microcomputer (without circuit board or program options).

1. Connect and power up all of your hardware devices.

Refer to the manuals for each device to be sure that it is properly connected and turned on. In general, all of the "on-off" switches should be in the "on" position. When turned on, your microcomputer should display a series of random digits on the LED (Light Emitting Diode) panel.

2. If not, then you can reset the H-8 by pressing the **0** (lower left-hand) and **ALTER / RST/0** (lower right-hand) keypad keys simultaneously.
3. Insert your CP/M Distribution Disk (or Distribution Disk I) into your primary boot drive. You can determine which drive is your primary boot drive by the following guidelines:
 - If you have an H/Z-37, H/Z-47, H/Z-77, H/Z-87, or H/Z-17-3 drive model, insert the disk into the drive slot on the left-hand side of the drive model.

- If you have more than one type of disk drive, insert the disk into the left-hand slot of the drive model that accommodates your Distribution Disk.
 - If you have an H/Z-67 Winchester Disk drive model which does not yet contain the operating system, insert the Distribution Disk into the 8-inch floppy disk drive slot on the right-hand side of the H/Z-67 drive model.
 - If you have an H/Z-67 drive model in which the Winchester Disk already contains a copy of the operating system, insert nothing and proceed to step 4.
4. Make the following entries in sequence, by pressing the appropriate keys on the H-8 keypad:

**REG
PC
ALTER
030000
ALTER
GO**

The H-8 should respond to this entry by displaying one of the following LED messages:

Pri H17 or Pri H47

(The precise display that follows your bootstrap command depends on the kind of disk drive you are booting from.)

5. Press the **space bar** of the console keyboard several times. These entries should complete a successful bootstrap (cold boot), which loads a copy of the CP/M Operating System from your Distribution Disk into your microcomputer.

When you have performed a successful bootstrap (cold boot), the light on disk drive A: will glow to indicate that the disk drive is reading the CP/M Operating System from the disk and sending a copy of it into microcomputer memory. (If drive A: is a Winchester Disk partition, no light will glow.) When this CP/M system copy enters the microcomputer, it identifies itself by displaying a message in the following form:

nnK HEATH/ZENITH CP/M 2.2.04 09/15/82
FOR Hdd DISKS WITH OPTION(S) cccc

Where “nn” is the number of K (kilobytes) of data CP/M is capable of handling now. Make note of this number for future reference;

where “2.2.04” is the version number of your CP/M system. Make note of this version number for future reference;

where “dd” is a number that stands for the kind of disk drives that this CP/M image is capable of controlling now; and

where “cccc” is a group of letters and or numbers that stand for some of the characteristics of this CP/M image.

After identifying itself, CP/M will automatically invoke the “Heath/Zenith Configuration Program”, which will display further messages.

NOTE: When you boot up with a CP/M disk other than your Distribution Disk, CP/M might not automatically invoke the “Configuration Program”, but instead display the “A>” system prompt immediately after the CP/M identification message. If you boot up with the Setup Utility Disk, Setup displays will appear instead of identification messages or a system prompt.

If you are booting up to a new CP/M Distribution Disk, or a new CP/M Backup Disk operating system copy that has not yet been completely customized, then the CP/M identification message may be automatically followed by several additional messages, displayed in the following form:

```
Heath/Zenith Configuration Program
Version 2.2.04
Serial number sss-ssss
```

```
This program configures the CP/M operating system to a
particular hardware environment
```

```
Please wait during hardware verification. . .
```

```
H8 with 48k of random access memory (RAM)
03 minifloppy drives
H/Z47 8 inch floppy disk interface
CRT baud rate is 9600
02 additional serial ports found
```

```
Drive A disk is write protected.
Modifications will NOT be made to the disk for this CONFIGUR run.
```

```
Standard system (Y or N) <Y>:
```

The "Configuration Program" that CP/M invoked automatically is the transient command (utility) called "CONFIGUR". When invoked, CONFIGUR automatically surveys characteristics of some of the devices in your hardware environment.

6. The "Standard system" prompt can enable you to access the CP/M Operating System immediately if you enter Y. If you enter Y, CP/M will display the "A>" system prompt.

NOTE: If you are booting up as part of a procedure, read the instructions of this procedure to determine whether or not it would be desirable for you to enter Y at this prompt.

Bootstrap will be a frequent activity in future procedures.

Startup Procedure Three

H-8 Microcomputer with PAM-8

This procedure consists of six steps to help you start up the CP/M Operating System in your H-8 microcomputer with the PAM-8 Panel Monitor Program.

1. Connect and power up **all** of your hardware devices.

Refer to the manuals for each device to be sure that it is properly connected and turned on. In general, all of the "on-off" switches should be in the "on" position. When turned on, your microcomputer should display one of the following messages on the LED (Light Emitting Diode) panel:

177377 SP or 277377 SP or 377377 SP

(The exact display you see reflects the current octal address value of the Set Pointer register, which depends on the amount of memory that has been installed in your computer.)

2. If one of these displays does not appear after you turn the computer on (or if another display replaces it before you make an entry), then press the **0** (lower left-hand) and **ALTER / RST/0** (lower right-hand) keypad keys simultaneously. This entry will reset the H-8.

3. Insert your CP/M Distribution Disk (or Distribution Disk I) into your primary boot drive. You can determine which drive is your primary boot drive by the following guidelines:
 - If you have an H/Z-37, H/Z-47, H/Z-77, H/Z-87, or H/Z-17-3 drive model, insert the disk into the drive slot on the left-hand side of the drive model.
 - If you have more than one type of disk drive, insert the disk into the left-hand slot of the drive model that accommodates your Distribution Disk.
 - If you have an H/Z-67 Winchester Disk drive model which does not yet contain the operating system, insert the Distribution Disk into the 8-inch floppy disk drive slot on the right-hand side of the H/Z-67 drive model.
 - If you have an H/Z-67 drive model in which the Winchester Disk already contains a copy of the operating system, insert nothing and proceed to step 4.
4. Press the **4** (GO) key on the H-8 keypad. The H-8 should respond to this entry by displaying one of the following LED messages:

Pri H17 or Pri H47

(The precise display that follows your bootstrap command depends on the kind of disk drive you are booting from.)

5. Press the **space bar** of the console keyboard several times. These entries should complete a successful bootstrap (cold boot), which loads a copy of the CP/M Operating System from your Distribution Disk into your microcomputer.

When you have performed a successful bootstrap (cold boot), the light on disk drive A: will glow to indicate that the disk drive is reading the CP/M Operating System from the disk and sending a copy of it into microcomputer memory. (If drive A: is a Winchester Disk partition, no light will glow.) When this CP/M system copy enters the microcomputer, it identifies itself by displaying a message in the following form:

```
nnK HEATH/ZENITH CP/M 2.2.04 09/15/82
FOR Hdd DISKS WITH OPTION(S) cccc
```

Where "m" is the number of K (kilobytes) of data CP/M is capable of handling now. Make note of this number for future reference;

where "2.2.04" is the version number of your CP/M system. Make note of this version number for future reference;

where "ad" is a number that stands for the kind of disk drives that this CP/M image is capable of controlling now; and

where "cccc" is a group of letters and or numbers that stand for some of the characteristics of this CP/M image.

After identifying itself, CP/M will automatically invoke the "Heath/Zenith Configuration Program", which will display further messages.

NOTE: When you boot up with a CP/M disk other than your Distribution Disk, CP/M might not automatically invoke the "Configuration Program", but instead display the "A>" system prompt immediately after the CP/M identification message. If you boot up with the Setup Utility Disk, Setup displays will appear instead of CP/M messages or a system prompt.

If you are booting up to a new CP/M Distribution Disk, or a new CP/M Backup Disk operating system copy that has not yet been completely customized, then the CP/M identification message may be automatically followed by several additional messages, displayed in the following form:

```
Heath/Zenith Configuration Program
Version 2.2.04
Serial number sss-sssss
```

```
This program configures the CP/M operating system to a
particular hardware environment
```

```
Please wait during hardware verification. . .
```

```
H8 with 48k of random access memory (RAM)
03 minifloppy drives
H/Z47 8 inch floppy disk interface
CRT baud rate is 9600
02 additional serial ports found
```

```
Drive A disk is write protected.
Modifications will NOT be made to the disk for this CONFIGUR run.
```

```
Standard system (Y or N) <Y>:
```

The "Configuration Program" that CP/M invoked automatically is the transient command (utility) called "CONFIGUR". When invoked, CONFIGUR automatically surveys characteristics of some of the devices in your hardware environment.

6. The "Standard system" prompt can enable you to access the CP/M Operating System immediately if you enter Y. If you enter Y, CP/M will display the "A>" system prompt.

NOTE: If you are booting up as part of a procedure, read the instructions of this procedure to determine whether or not it would be desirable for you to enter Y at this prompt.

Bootstrap will be a frequent activity in future procedures.

Startup Procedure Four

H-8 Microcomputer with HA8-8

This procedure consists of six steps to help you start up the CP/M Operating System in your H-8 microcomputer with the HA8-8 Extended Configuration Board.

1. Connect and power up **all** of your hardware devices.

Refer to the manuals for each device to be sure that it is properly connected and turned on. In general, all of the "on-off" switches should be in the "on" position. When turned on, your microcomputer should display one of the following messages on the LED (Light Emitting Diode) panel:

177377 SP or 277377 SP or 377377 SP

(The exact display you see reflects the current octal address value of the Set Pointer register, which depends on the amount of memory that has been installed in your computer.)

2. If one of these displays does not appear after you turn the computer on (or if another display replaces it before you make an entry), then press the **0** (lower left-hand) and **ALTER / RST/0** (lower right-hand) keypad keys simultaneously. This entry will reset the H-8.

3. Insert your CP/M Distribution Disk (or Distribution Disk I) into your primary boot drive. You can determine which drive is your primary boot drive by the following guidelines:
 - If you have an H/Z-37, H/Z-47, H/Z-77, H/Z-87, or H/Z-17-3 drive model, insert the disk into the drive slot on the left-hand side of the drive model.
 - If you have more than one type of disk drive, insert the disk into the left-hand slot of the drive model that accommodates your Distribution Disk.
 - If you have an H/Z-67 Winchester Disk drive model which does not yet contain the operating system, insert the Distribution Disk into the 8-inch floppy disk drive slot on the right-hand side of the H/Z-67 drive model.
 - If you have an H/Z-67 drive model in which the Winchester Disk already contains a copy of the operating system, insert nothing and proceed to step 4.
4. Press the 1 (number one) key on the H-8 key pad. The H-8 should respond to this entry by displaying one of the following LED messages:

Pri H17 or Pri H47

(The precise display that follows your bootstrap command depends on the kind of disk drive you are booting from.)
5. Press the **space bar** of the console keyboard several times. These entries should complete a successful bootstrap (cold boot), which loads a copy of the CP/M Operating System from your Distribution Disk into your microcomputer.

When you have performed a successful bootstrap (cold boot), the light on disk drive A: will glow to indicate that the disk drive is reading the CP/M Operating System from the disk and sending a copy of it into microcomputer memory. (If drive A: is a Winchester Disk partition, no light will glow.) When this CP/M system copy enters the microcomputer, it identifies itself by displaying a message in the following form:

```
nnK HEATH/ZENITH CP/M 2.2.04 09/15/82
FOR Hdd DISKS WITH OPTION(S) cccc
```

Where "nn" is the number of K (kilobytes) of data CP/M is capable of handling now. Make note of this number for future reference;

where "2.2.04" is the version number of your CP/M system. Make note of this version number for future reference;

where "dd" is a number that stands for the kind of disk drives that this CP/M image is capable of controlling now; and

where "cccc" is a group of letters and or numbers that stand for some of the characteristics of this CP/M image.

After identifying itself, CP/M will automatically invoke the "Heath/Zenith Configuration Program", which will display further messages.

NOTE: When you boot up with a CP/M disk other than your Distribution Disk, CP/M might not automatically invoke the "Configuration Program", but instead display the "A>" system prompt immediately after the CP/M identification message. If you boot up with the Setup Utility Disk, Setup displays will appear instead of CP/M messages or a system prompt.

If you are booting up to a new CP/M Distribution Disk, or a new CP/M Backup Disk operating system copy that has not yet been completely customized, then the CP/M identification message may be automatically followed by several additional messages, displayed in the following form:

```
Heath/Zenith Configuration Program
Version 2.2.04
Serial number sss-sssss
```

```
This program configures the CP/M operating system to a
particular hardware environment
```

```
Please wait during hardware verification. . .
```

```
H8 with 48k of random access memory (RAM)
03 minifloppy drives
H/Z47 8 inch floppy disk interface
CRT baud rate is 9600
02 additional serial ports found
```

```
Drive A disk is write protected.
Modifications will NOT be made to the disk for this CONFIGUR run.
```

```
Standard system (Y or N) <Y>:
```

The “Configuration Program” that CP/M invoked automatically is the transient command (utility) called “CONFIGUR”. When invoked, CONFIGUR automatically surveys characteristics of some of the devices in your hardware environment.

6. The “Standard system” prompt can enable you to access the CP/M Operating System immediately if you enter Y. If you enter Y, CP/M will display the “A>” system prompt.

NOTE: If you are booting up as part of a procedure, read the instructions of this procedure to determine whether or not it would be desirable for you to enter Y at this prompt.

Bootstrap will be a frequent activity in future procedures.

Unsuccessful Startup

If the CP/M identification message does not appear within a minute after your bootstrap command, then reset your microcomputer (step 2) and repeat your bootstrap command (step 4).

If your bootstrap command again fails to produce the CP/M identification message or automatic execution of a program that runs under CP/M, then check the following:

- That all components of your hardware environment have been properly connected and powered up. (See manuals for hardware devices.)
- That your bootable disk is within the proper drive slot. (Try the same command with the disk in a different drive; or try an alternate bootstrap command, as explained in Appendix C: “Bootstrap”.)
- That your disk is properly situated in the drive and the drive closed. (See the text in this manual entitled “Microcomputer Concepts”.)
- That your disk is composed of the proper media for your disk drives. (See the manual for your disk drive.)
- That the switches on your CPU circuit board are in the correct positions for your disk drives. (See the manual for your microcomputer.)

SETUP PROCEDURE

Introduction

SPECIAL FEATURES

Setup automatically creates a CP/M system adapted for almost any Heath/Zenith hardware environment except those that include H/Z-67 Winchester drives or small memory capacities.

If you do not have an H/Z-67 Winchester disk drive, and if your computer contains at least 48 kilobytes of random access memory, then you can use Setup instead of following "Backup Procedures", "Customizing Procedures", and "Working Disk Procedures".

If you have an H/Z-67 Winchester disk drive, and/or if your computer contains less than 48 kilobytes of random access memory, then do not use Setup. Proceed immediately to the text entitled "Backup Procedures". After using a backup procedure, you should continue to "Customizing Procedures", and "Working Disk Procedures".

Setup enables even computer novices to create bootable system and application disks designed to meet their special needs, merely by pressing a few keys and viewing several helpful illustrations.

Special features of Setup include:

- Fast creation of CP/M bootable applications disks with automated use of FORMAT, SYSGEN, MOVCPM and PIP
- Clear, easy-to-follow displays
- Use on most combinations of Zenith Data Systems/Heath equipment
- Quick customization routine for adding printers.

FUNCTIONAL OVERVIEW

Setup performs the following automatic activities:

- surveys your equipment (except for the printer) and displays illustrations of it for your approval
- displays the list of printers for you to specify the type of printer you might use
- asks you to insert a disk in any drive
- performs the equivalent of the CP/M operating system commands FORMAT, CONFIGUR, SYSGEN, MOVCPM, and PIP to create the proper BIOS and to copy system and application programs to the disk.

WHAT YOU NEED

In order to use Setup you need a H/Z-89/90 microcomputer with at least 48K of memory.

This version of Setup supports all possible combinations of the Zenith Data Systems/Heath equipment listed in Table 1-1.

Microcomputer	Disk Drive	Printer
Z-89 or H-89	Z-17 or H-17	Diablo 630 (WH54)
Z-90 or H-90	Z-37 or H-37	Diablo 1610
Z-19 or H-19	Z-47 or H-47	Diablo 1620
	Z-87 or H-87	Diablo 1640
	Z-77 or H-77	Diablo 1650
		LA-36 (H-36)
		LA-34 (WH-34)
		H-14
		WH-14
		WH-24 (TI-810)
		Epson MX-80
		Z-25 (H-25)
		Custom
Special: Votrax Type-'N-Talk		

Table 1-1
Equipment Supported by Setup

When you use Setup, be sure to have on hand a supply of blank or ready to be erased disks of the type that your disk drives require.

Using Setup

Setup helps you create a disk that is tailored for your printer and that contains application files of your choice. Supported hardware includes any combination of Zenith/Heath Data Systems microcomputer equipment — except for the H/Z-67 Winchester disk or any computer with less than 48 kilobytes of random access memory. Printers supported include both standard printers and custom printers.

Prepare a backup copy of the Setup Utility Disk before attempting any other procedure.

STANDARD PRINTERS

Setup enables you to specify and install the printer you are using if you simply press the key that describes your printer while you view the printer selection menu. Printers listed on the printer selection menu include:

Diablo 630 (WH54)
Diablo 1610
Diablo 1620
Diablo 1640
Diablo 1650
LA-36 (WH-54)
H-14
WH-24 (TI-810)
Z-25 (H-25)

Votrax Type 'N Talk (although not a printer) is also listed.

Setup enables you to add a custom printer to the printer selection menu with just a few more steps.

CUSTOM PRINTERS

Adding another printer to the printer selection menu means that you can select and install it again later by simply pressing a key. Adding another printer involves a special procedure in which you specify the printer characteristics:

- Baud rate (75-38400)
- Printer ready signal polarity (high or low)
- Printer ready signal type (DTR or RTS)
- Printer physical type (LPT or UL1)
- Communications method (serial or parallel)
- Printer name (up to 33 characters)

Refer to your printer hardware manual if you are unsure of these characteristics for your printer.

Any printer previously on the printer selection list which you would like to configure in a nonstandard way (refer to the text entitled "Troubleshooting", for standard baud settings) may also be added with the special procedure.

IMPORTANCE OF MAKING BACKUPS

Make a backup copy of Setup right away. Making a backup copy allows you to put the original away for safekeeping and to use the backup for daily work.

Because backing up disks is so important, Setup provides a very easy backup procedure — you can use the Setup disk to back itself up. Simply insert the Setup disk and press the B key to boot the program. Then follow the instructions in Procedure for Using Setup.

SPECIAL CAUTIONS:

Before you begin to use Setup, make sure that you have:

- Connected all of your equipment properly and according to the instructions in your hardware manual. If you need help, ask for assistance from your dealer.
- Made available a disk to receive the operating system and application files. **WARNING:** This disk (called the “destination disk”) is erased during Setup.
- A disk from which to copy the application files, that is, the “source disk.”
- **If you are backing up the Setup disk**, all you need is a disk of the same type as the Setup distribution disk — that is, it should be of the same size, TPI (tracks per inch) and use the same number of sides.

PROCEDURE FOR USING SETUP

Allow up to five minutes for completion of this procedure with multiple-drive hardware and up to 10 minutes with single-drive hardware.

1. Turn on all of your hardware and verify that it is connected properly. Refer to your hardware manual if necessary. The terminal should sound two “beeps” when turned on.
2. Insert the Setup Utility Disk. Then close the drive latch or door.

3. Boot up with the drive containing the Setup Utility Disk. The Setup utility will be invoked automatically and a menu will appear, as shown in Figure 1-4.

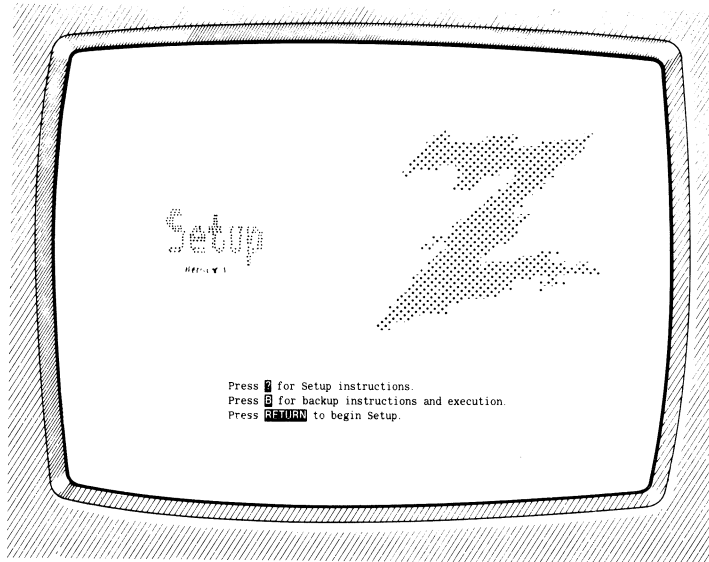

Figure 1-4
Initial Setup Display

4. If this is the first time you are using Setup, press B to start backing up your disk immediately.
5. Follow the instructions that are displayed on the screen by Setup.
6. Be sure to label your disks right away. After completing a backup procedure, always store the original disk in a safe place.

Troubleshooting

If for some reason your system does not work after you use Setup, be sure to reread the instructions and repeat the procedure first. Then, if you still have problems, read some of the following instructions related to: problems with your printer, identifying a Setup illustration, or the list of error messages.

PRINTER PROBLEMS

Zenith Data Systems/Heath supports printers that have selectable settings for the baud rate. If your printer is set for a baud rate not anticipated by Setup, printing problems can result when you use the application disk.

Check the baud setting on your printer by referring to the printer manual. The following list shows the baud rates that Setup will assume your printer has if you select a printer by name.

<u>PRINTER NAME</u>	<u>ANTICIPATED BAUD RATE</u>
Diablo 630 (WH-54)	1200
Diablo 1610	1200
Diablo 1620	1200
Diablo 1640 (WH-44)	1200
Diablo 1650	1200
LA-36 (H-36)	300
LA-34 (WH-34)	300
H-14	4800
WH-14	4800
WH-24 (TI-810)	4800
Epson MX-80	4800
Z-25 (H-25)	4800

If the baud settings do not match, change the setting on your printer or refer to Setup's custom printer procedure to adapt your disks to your printer's baud rate.

SETUP ILLUSTRATIONS

If you had any difficulty identifying any of the hardware illustrations that Setup uses, Figure 1-5 identifies the illustrations as they look on screen.

 <p>Z-89, Z-90</p>	 <p>H-37</p>
 <p>Z-47</p>	 <p>H-87</p>
 <p>Z-19</p>	 <p>PRINTER Z-25</p>
 <p>SINGLE DRIVE H-87</p>	 <p>SINGLE DRIVE H-37</p>

Figure 1-5
Setup Illustrations Identified

SETUP ERROR MESSAGES

Setup error messages are displayed on your terminal when a hardware failure, software failure, or user failure prevents Setup from performing its function. To help you deal with such failures, most of these error messages explain the reason for the failure and the action that you should take to correct it. Setup also uses some of the standard error messages of CPM utilities, so you should refer to the error message texts for utilities in Appendix A: "Operating System Error Messages" for explanations of messages not listed here. This section shows Setup's error messages.

Setup was unable to find a disk in the disk drives.
Press RETURN to begin Setup again.

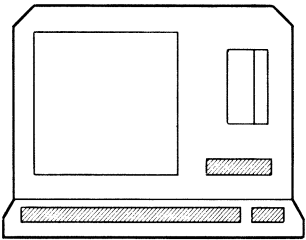
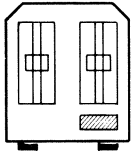
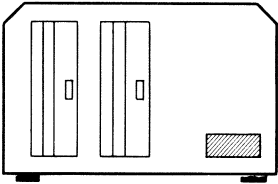
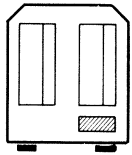
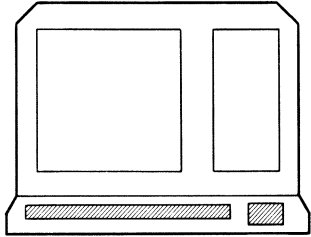
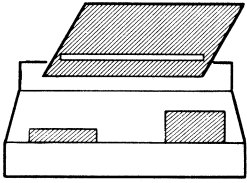
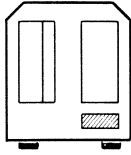
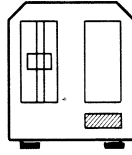
Setup was unable to find the source disk. At this point, your destination disk is bootable but contains no application files. Press RETURN to continue.

An error occurred during your selection of a printer. Setup will continue, but after you have finished copying application files to your destination disk, you should verify that your printer has been correctly installed.
Press RETURN to continue.

An error occurred during the transferring of files from the source disk to the destination disk. At this point, your destination disk will be bootable and contain some, but not all of your application files. You should now check the status of your files, but first press RETURN to end Setup.

An error occurred as the automatic command was being copied from the source disk to the destination disk. The destination WILL contain all the application files. You can set the automatic command line using the CONFIGUR utility.
Press RETURN to continue.

An error occurred when Setup tried to read a file off the disk. This can happen when:

- * the proper file is not on the Setup disk.
- * the proper file is damaged on the Setup disk.
- * the Setup disk was not in the proper drive when needed.

If this is the first time you have received this message, try the Setup procedure again. Otherwise, make a new backup of your Setup master and use that instead of your present Setup disk.

Press RETURN to continue.

***** An error occurred during the Setup procedure *****

NOTE: The last error message listed occurs after you have taken the prescribed corrective action in response to another error message, and this corrective action also fails to produce the desired results. When this error message occurs, reset the computer (press the right-hand **SHIFT** and **RESET** keys simultaneously) and repeat the bootup procedure with the Setup disk. You will then have to repeat the Setup procedure during which you received the error message.

BACKUP PROCEDURES

A “backup” is a floppy disk or a Winchester Disk partition that contains the same software items as your CP/M distribution media.

We strongly recommend that you make a backup the first time you boot up with a CP/M Distribution Disk. Making backups will help you to protect your software investment.

Because Heath/Zenith offers such a wide range of hardware devices, different users require different procedures for making backups in their own hardware environment. Therefore, this section contains five different procedures for constructing backups. You will need to use only one backup procedure.

To determine which procedure is right for you, refer to Table 1-2. Then turn to your procedure and follow the step-by-step instructions for this procedure.

If you feel that you can perform the procedure without step-by-step instructions, then you can use the “Procedure Synopsis” at the beginning of the procedure for an overview of the steps involved.

Some of the following procedures advise you to back up your software to disks of the “same type”. Disk type, for these procedures, is defined by the following criteria:

- disk material: floppy or Winchester;
- disk size: 5.25-inch or 8-inch;
- sector form: hard-sectored or soft-sectored;
- track density: 48 or 96 tracks per inch (TPI);
- side quantity: single-sided or double-sided; and
- surface density: single-density or double-density or extended double-density.

Some of these criteria are determined by the disk manufacturer, and some are determined by you when you prepare the surface of the disk with the FORMAT utility. The disks you use for backups should be equal to your Distribution Disks in each of these criteria. However, users of 96 TPI drives should back up their three CP/M Distribution Disks to a single 96 TPI disk — even though their CP/M distribution software is recorded on 48 TPI disks.

You can use these procedures to back up any disk, by substituting the disk you wish to back up for the CP/M Distribution Disk.

The backup procedure you use is determined by the kind of drive you used to boot up. You booted up using a drive slot from your primary drive group. Find the description of your primary drive group on the left side of the table. The backup procedure listed to the right of this description is the procedure you should use to backup your CP/M distribution software.

PRIMARY DRIVE GROUP DESCRIPTION	PROPER BACKUP PROCEDURE	PAGE
One 48 TPI, 5.25-inch drive	Backup Procedure One	1-60
One 96 TPI, 5.25-inch drive	Backup Procedure One	1-60
Two 48 TPI, 5.25-inch drives	Backup Procedure Two	1-75
Three 48 TPI, 5.25-inch drives	Backup Procedure Two	1-75
Two 48 TPI, 8-inch drives (H-47 or Z-47)	Backup Procedure Two	1-75
Two 96 TPI, 5.25-inch drives	Backup Procedure Three	1-82
Two 96 TPI, 5.25-inch drives and one 48 TPI, 5.25-inch drive	Backup Procedure Three	1-82
Three 96 TPI, 5.25-inch drives	Backup Procedure Three	1-82
One 96 TPI, 5.25-inch drive and one 48 TPI, 5.25-inch drive	Backup Procedure Four	1-91
One 96 TPI, 5.25-inch drive and two 48 TPI, 5.25-inch drives	Backup Procedure Four	1-91
One Winchester/floppy drive (H-67 or Z-67)	Backup Procedure Five	1-102

Table 1-2
Backup Procedures

Backup Procedure One

One Primary 5.25-inch Floppy Disk Drive

This procedure is used to backup CP/M distribution software. To perform this procedure, you will copy both the CP/M Operating System and the utility files from your distribution disks to blank disk media.

You have three CP/M Distribution Disks with software recorded at 48 TPI.

If the disk drive that accommodates your CP/M Distribution Disks is a 5.25-inch, 48 TPI, hard-sectored drive, then you will copy the distribution software to three, blank, 5.25-inch, hard-sectored disks. Prepare for this procedure by labelling these three blank disks "CP/M Backup Disk I", "CP/M Backup Disk II", and "CP/M Backup Disk III".

If the disk drive that accommodates your CP/M Distribution Disks is a 5.25-inch, 48 TPI, soft-sectored drive, then you will copy the distribution software to three, blank, 5.25-inch, 48 TPI, soft-sectored disks. Prepare for this procedure by labelling these three blank disks "CP/M Backup Disk I", "CP/M Backup Disk II", and "CP/M Backup Disk III".

If the disk drive that accommodates your CP/M Distribution Disks is a 5.25-inch, 96 TPI, soft-sectored drive, then you will copy the distribution software to one, blank, 5.25-inch, 96 TPI, soft-sectored disk. Prepare for the procedure by labelling the disk "CP/M Backup Disk".

NOTE: The blank disks that you use to back up distribution software should be write enabled during this entire procedure. Therefore, do not cover the notches of these blank disks with write-protect tabs.

PROCEDURE SYNOPSIS

This procedure requires you to perform the following activities in sequence:

- boot up
- CONFIGUR
- FORMAT
- SYSGEN
- PIP

To begin Procedure One, boot up with Distribution Disk I. The CONFIGUR utility will be invoked automatically. Proceed to the CONFIGUR activity.

CONFIGUR

This CONFIGUR activity customizes the operating system that you placed in memory when you performed bootstrap so that you can copy data to your backup disk(s). There are two methods for performing this CONFIGUR activity, so use **ONLY** the method specified below for your primary drive group.

If your primary drive (the one used for bootstrap) is a 48 TPI drive, then use Method A for this CONFIGUR activity.

If your primary drive (the one used for bootstrap) is a 96 TPI drive, then use Method B for this CONFIGUR activity.

Method A

When the CONFIGUR utility is automatically invoked, it will display several messages. When CONFIGUR displays the message:

```
STANDARD SYSTEM (Y OR N)? <Y>:
```

type Y. The CONFIGUR activity will end, and CP/M will display the A> system prompt.

Proceed to the FORMAT activity.

Method B

When the CONFIGUR utility is automatically invoked, it will display several messages. When CONFIGUR displays the message:

```
STANDARD SYSTEM (Y OR N)? <Y>:
```

type the sequence of keyboard entries listed in Table 1-3. To the right of each entry is an excerpt or description of the part of the display that should appear immediately **after** you type the entry.

Keyboard Entries	Excerpt or Description of Desired Display
N	CP/M CONFIGURATION (Main Menu)
B	5.25 INCH SOFT-SECTORED UNIT 0 STEP RATE: 30MS TRACK DENSITY: 48TPI
A	SOFT SECTOR UNIT 0 STEP RATE ?
6	SOFT SECTOR UNIT 0 STEP RATE ? 6
RETURN	SOFT SECTOR UNIT 0 TRACK DENSITY ?
96	SOFT SECTOR UNIT 0 TRACK DENSITY ? 96
RETURN	5.25 INCH SOFT-SECTORED UNIT 0 STEP RATE: 6M TRACK DENSITY: 96TPI
Y	CP/M CONFIGURATION (Main Menu)
X	A> (CP/M system prompt)

Table 1-3
CONFIGUR Entries for One 96 TPI Drive

When the A> system prompt appears, proceed to the FORMAT activity.

NOTE: If the display excerpted or described in the table does not appear, read the CONFIGUR text in "Volume II: The CP/M Reference Guide".

FORMAT

This FORMAT activity helps you prepare backup disk media for data storage. The method you use to operate FORMAT depends on the type of disk you are preparing. Use only one of the three FORMAT methods specified below:

If your CP/M Backup Disks are 5.25-inch, 48 TPI, hard-sectored disks, then use Method A to FORMAT and follow the numbered steps preceded by the letter A.

If your CP/M Backup Disks are 5.25-inch, 48 TPI, soft-sectored disks, when use Method B to FORMAT and follow the numbered steps preceded by the letter B.

If your CP/M Backup Disk is a 5.25-inch, 96 TPI, soft-sectored disk, then use Method C to FORMAT and follow the numbered steps preceded by the letter C.

Method A:

- A1. At the A> System Prompt, type **FORMAT** and press **RETURN**. This entry invokes FORMAT, which displays a message in the following form:

```
Format Version 2.04
This program is used to initialize a disk.
All information currently on the disk will be destroyed.
Is that what you want? (y/n):
```

- A2. Type **Y**. FORMAT will display:

```
Which drive do you wish to use for this operation?
```

- A3. Type **A**. FORMAT will display:

```
Put the disk you wish to be formatted in drive A.
Press RETURN to begin, anything else to abort.
```

- A4. Remove Distribution Disk I, and insert Backup Disk I. Then close the disk drive door and press **RETURN**.

- A5. The light on the disk drive will glow for several seconds. Then FORMAT will display:

```
Do you have more disks to format? (y/n):
```

- A6. If you have three Distribution Disks and have not yet formatted three Backup Disks, then type **Y** at this prompt, and resume the FORMAT activity at Step A4 by inserting a different Backup Disk.

If you have formatted all three of your Backup disks then type **N** and FORMAT will display:

```
Place a bootable disk in drive A and press any character:
```

- A7. Remove the last formatted Backup Disk and insert Distribution Disk I. Then type any character. CP/M will display:

```
A>
```

Leave Distribution Disk I in the drive and proceed to SYSGEN.

Method B:

- B1. At the A> System Prompt, type **FORMAT** and press **RETURN**. This entry invokes FORMAT, which displays the following:

```
Format Version 2.04
This program is used to initialize a disk.
All information currently on the disk will be destroyed.
Is that what you want? (y/n):
```

- B2. Type **Y**. FORMAT will display:

```
Which drive do you wish to use for this operation?
```

- B3. Type **A**. FORMAT will display:

```
Put the disk you wish to be formatted in drive A.
Press RETURN to begin, anything else to abort.
```

- B4. Type **S**. FORMAT will display:

```
Number of sides? (1=single, 2=double):
```

- B5. Type **1**. FORMAT will display the following message and prompt:

```
48 TPI drive -- 40 tracks will be formatted

Put the disk you wish to be formatted in drive A.
Press RETURN to begin, anything else to abort.
```

NOTE: If the message does not indicate "48 TPI drive", then reset the computer and start over at the beginning of Backup Procedure One.

- B6. Immediately remove Distribution Disk I and replace it with Backup Disk I. Then close the disk drive, and press **RETURN**.

- B7. The light on the disk drive will glow for several seconds. Then FORMAT will display:

```
Do you have more disks to format? (y/n):
```

- B8. If you have not yet formatted three Backup Disks, then type **Y** at this prompt, and resume the **FORMAT** activity at Step B3. (Insert a different Backup Disk at Step B6.)

If you have formatted all three Backup Disks, then type **N** and **FORMAT** will display:

Place a bootable disk in drive A and press any character:

- B9. Remove the last formatted Backup Disk and insert Distribution Disk I. Then type any character. **CP/M** will display:

A>

With Distribution Disk I in the drive, proceed to **SYSGEN**.

Method C:

- C1. At the A> System Prompt, type **FORMAT** and press **RETURN**. This entry invokes **FORMAT**, which displays the following:

```
Format Version 2.04
This program is used to initialize a disk.
All information currently on the disk will be destroyed.
Is that what you want? (y/n):
```

- C2. Type **Y**. **FORMAT** will display:

Which drive do you wish to use for this operation?

- C3. Type **A**. **FORMAT** will display:

Which density? (S=single, D=double):

- C4. Type **D**. **FORMAT** will display:

Number of sides? (1=single, 2=double):

- C5. Type **2**. **FORMAT** will display the following message and prompt:

96 TPI drive -- 80 tracks will be formatted

Put the disk you wish to be formatted in drive A.
Press **RETURN** to begin, anything else to abort.

NOTE: If the message does not indicate "96 TPI drive", then reset the computer and go back to the beginning of Backup Procedure One and start over.

C6. Immediately remove Distribution Disk I and replace it with the Backup Disk. Then close the disk drive, and press **RETURN**.

C7. The light on the disk drive will glow for several seconds. Then FORMAT will display:

Do you have more disks to format? (y/n):

C8. Type **N** and FORMAT will display:

Place a bootable disk in drive A and press any character:

C9. Remove the Backup Disk and insert Distribution Disk I. Then type any character. CP/M will display:

A>

With Distribution Disk I in the drive, proceed to SYSGEN.

SYSGEN

The SYSGEN utility copies the CP/M Operating System to a disk. Use SYSGEN to copy the CP/M Operating System from Distribution Disk I to the Backup Disk (or Backup Disk I).

1. At the A> prompt, type **SYSGEN** and press **RETURN**. This entry invokes SYSGEN, which displays a message in the following form:

```
SYSGEN VER 2.0.04
SOURCE DRIVE NAME (OR RETURN TO SKIP):
```

2. Type **A**. SYSGEN will display:

```
SOURCE ON A, THEN TYPE RETURN
```

3. Press **RETURN**. SYSGEN will display:

```
FUNCTION COMPLETE.
COPY BIOS.SYS (Y/N):
```

4. Type **Y**. SYSGEN will display:

FUNCTION COMPLETE
DESTINATION DRIVE NAME (OR RETURN TO REBOOT):

5. Type **B**. SYSGEN will display:

DESTINATION ON B, THEN TYPE RETURN

6. Press **RETURN**. SYSGEN will display the following prompt:

PUT DISK B IN DRIVE A: AND PRESS RETURN

7. Remove Distribution Disk I and insert Backup Disk I (or the Backup Disk). Then press **RETURN**. SYSGEN will display the following:

FUNCTION COMPLETE.
DESTINATION DRIVE NAME (OR RETURN TO REBOOT):

8. Press **RETURN**. SYSGEN will display the following prompt:

PUT DISK A IN DRIVE A: AND PRESS RETURN

9. Remove Backup Disk I, and insert Distribution Disk I. Then press **RETURN**. CP/M will display:

A>

With Distribution Disk I in the drive, proceed to PIP.

PIP

The PIP utility copies files between disks.

The method you use to operate PIP depends on the type of disk media that will receive the copied distribution software. Use only one of the two PIP methods specified below:

If you have three, 5.25-inch, 48 TPI, backup disks (hard-sectored or soft-sectored), then use PIP Method A and follow the numbered steps preceded by the letter A.

If you have one, 5.25-inch, 96 TPI, backup disk, then use PIP Method B and follow the numbered steps preceded by the letter B.

Method A

A1. At the A> prompt, type the following command:

A>PIP B:=A:*. * RETURN

(*.* is an ambiguous or wildcard file name that stands for all of the files on Distribution Disk I.)

PIP will begin to copy the files one by one, and display the name of each file in the form:

COPYING -
FILENAME. EXT

Temporarily assign the following identities to your disks:

Distribution Disk I is "DISK A"; and
Backup Disk I is "DISK B".

PIP will prompt you to insert these disks alternately by displaying messages in the following form:

PUT DISK B IN DRIVE A: AND PRESS RETURN

A2. Whenever prompted by one of these messages, put the appropriate disk in the drive and press **RETURN**. PIP will require several disk switches before all of the Distribution Disk files are copied to the Backup Disk. When PIP finishes copying the files, CP/M will display a system prompt.

A3. Type **PIP B:=C:*. * RETURN** at the A> system prompt. (*.* is an ambiguous or wildcard file name that stands for all of the files on Distribution Disk II.)

A4. Temporarily assign the following identities to your disks:

Distribution Disk I is "DISK A";
Backup Disk II is "DISK B"; and
Distribution Disk II is "DISK C".

PIP will prompt you to insert these disks alternately. The prompts will appear in the following form:

PUT DISK B IN DRIVE A: AND PRESS RETURN

Whenever prompted by a message in this form, put the appropriate disk in the drive and press **RETURN**. PIP will require several disk switches before all of Distribution Disk II files are copied to Backup Disk II. When PIP has finished copying the files, you should end up with "DISK A" (Distribution Disk I) in the drive. Then CP/M should redisplay the A> system prompt.

- A5. Type **PIP B:=C:*. * RETURN** at the A> system prompt, and assign the following identities to your disks:

Distribution Disk I is "DISK A";
Backup Disk III is "DISK B"; and
Distribution Disk III is "DISK C".

- A6. Insert disks as prompted. PIP will display the names of the files it is copying. When PIP has finished copying the files, you should end up with "DISK A" (Distribution Disk I) in the drive and CP/M will redisplay the A> system prompt.

- A7. Store your Distribution Disks in a safe place, and use your Backup Disks for upcoming activities.

After completing Step A7 of the PIP activity proceed to the text titled "Customizing Procedures".

Method B

- B1. At the A> prompt, type the following command:

A>**PIP B:=A:*. *[V] RETURN**

(*.* is an ambiguous or wildcard file name that stands for all of the files on Distribution Disk I.)

PIP will begin to copy the files one by one, and display the name of each file in the form:

COPYING -
FILENAME. EXT

Temporarily assign the following identities to your disks:

Distribution Disk I is "DISK A"; and
The Backup Disk is "DISK B".

PIP will prompt you to insert these disks alternately by displaying messages in the following form:

PUT DISK B IN DRIVE A: AND PRESS RETURN

- B2. Whenever prompted by one of these messages, put the appropriate disk in the drive and press **RETURN**. PIP will require several disk switches before all of the Distribution Disk files are copied to the Backup Disk. When PIP has finished copying the files, CP/M will redisplay the A> system prompt.
- B3. Type **PIP B:=C:*. * RETURN** at the A> system prompt. (*. * is an ambiguous or wildcard file name that stands for all of the files on Distribution Disk II.)
- B4. Temporarily assign the following identities to your disks:

Distribution Disk I is "DISK A";
The Backup Disk is "DISK B"; and
Distribution Disk II is "DISK C".

PIP will prompt you to insert these disks alternately. The prompts will appear in the following form:

PUT DISK B IN DRIVE A: AND PRESS RETURN

Whenever prompted by a message in this form, put the appropriate disk in the drive and press **RETURN**. PIP will require several disk switches before all of Distribution Disk II files are copied to the Backup Disk. When PIP has finished copying the files, you should end up with "DISK A" (Distribution Disk I) in the drive. Then CP/M should redisplay the A> system prompt.

- B5. Type **PIP B:=C:*. * RETURN** at the A> system prompt, and assign the following identities to your disks:

Distribution Disk I is "DISK A";
The Backup Disk is "DISK B"; and
Distribution Disk III is "DISK C".

- B6. Insert disks as prompted. PIP will display the names of the files it is copying. When PIP has finished copying the files, you should end up with "DISK A" (Distribution Disk I) in the drive. Then CP/M should redisplay the A> system prompt.
- B7. Store your CP/M Distribution Disks in a safe place, and use your CP/M Backup Disk for upcoming activities.

After completing Step B7 of the PIP activity proceed to the text titled "Customizing Procedures".

Backup Procedure Two

Two or Three Primary 48 TPI Drives (5.25-inch or 8-inch)

This procedure is used to construct a Backup Disk by copying both the CP/M Operating System and the utility files from your Distribution Disk(s) to blank disk(s) of the same type.

If you have 5.25-inch disks, your CP/M software is stored on three Distribution Disks. You must copy the data from each Distribution Disk to a corresponding Backup Disk. Prepare for this procedure by labelling three blank disks "CP/M Backup Disk I", "CP/M Backup Disk II", and "CP/M Backup Disk III".

If you have 8-inch disks, you have only one CP/M Distribution Disk. Label one blank 8-inch disk "CP/M Backup Disk".

NOTE: The blank disks you will convert into Backup Disks must be write enabled during all of the activities in this procedure. Therefore, if you have 5.25-inch disks, do not cover the Backup Disk notches with tabs. If you have 8-inch disks, cover the Backup Disk notch with a tab and press down the write-protect switch for the H/Z47 drive containing the Backup Disk.

PROCEDURE SYNOPSIS

This procedure requires you to perform the following activities in sequence:

```
bootstrap
CONFIGUR
FORMAT
DUP
```

To begin Procedure Two, insert the Distribution Disk (or Distribution Disk I) in drive A and the Backup Disk (or Backup Disk I) in drive B. Perform bootstrap. When the CONFIGUR utility is automatically invoked, wait for the "STANDARD SYSTEM" prompt and type **Y**.

Then proceed to the FORMAT activity.

FORMAT

This FORMAT activity prepares your Backup Disk(s) for data storage. FORMAT works differently depending on the type of disk you are using. Therefore, use the FORMAT method specified below:

If your distribution software is recorded on hard-sectored 5.25-inch disks, use Method A to FORMAT and follow the numbered steps preceded by the letter A.

If your distribution software is recorded on 8-inch disks or soft-sectored 5.25-inch disks, use Method B to FORMAT and follow the numbered steps preceded by the letter B.

Method A:

- A1. At the A> System Prompt, type **FORMAT** and press **RETURN**. This entry invokes FORMAT, which displays a message in the form:

```
Format Version 2.04
This program is used to initialize a disk.
All information currently on the disk will be destroyed.
Is that what you want? (y/n):
```

- A2. Type **Y**. FORMAT will display:

```
Which drive do you wish to use for this operation?
```

A3. Type **B**. **FORMAT** will display:

Put the disk you wish to be formatted in drive B.
Press **RETURN** to begin, anything else to abort.

A4. Make sure that the Backup Disk is properly situated in drive B, and press **RETURN**. The light on the disk drive will glow for several seconds. Then **FORMAT** will display:

Do you have more disks to format? (y/n):

A5. If you have three Distribution Disks, format Backup Disks for each volume by typing **Y** at this step, and resuming the **FORMAT** activity at Step A3.

If you have formatted all of your Distribution Disks, then type **N**. **CP/M** will display:

A>

Now proceed to the **DUP** activity.

Method B:

B1. After the **CP/M** prompt A>, type **FORMAT** and press **RETURN**. This entry invokes **FORMAT**, which displays a message in the form:

Format Version 2.04
This program is used to initialize a disk.
All information currently on the disk will be destroyed.
Is that what you want? (y/n):

B2. Type **Y**. **FORMAT** will display:

Which drive do you wish to use for this operation?

B3. Type **B**. **FORMAT** will display one of the following two messages:

Which density? (S=single, D=double):

or

Which density? (S=single, D=double, E=extended density):

B4. Type S.

If the Backup Disk is an 8-inch disk, proceed to Step B6.

If the Backup Disk is a 5.25 inch soft-sectored disk, FORMAT will display:

Number of sides? (1=single, 2=double):

B5. If your Backup Disk is a 5.25-inch soft-sectored disk, type 1. FORMAT will display:

48 TPI drive -- 40 tracks will be formatted

B6. FORMAT will now display the message:

Put the disk you wish to be formatted in drive B.
Press RETURN to begin, anything else to abort.

B7. Make sure that the Backup Disk is properly situated in drive B, and press RETURN. The light on the disk drive will glow for several seconds. Then FORMAT will display:

Do you have more disks to format? (y/n):

B8. If you have not yet formatted each of your Backup Disks, type Y at this step, and resume the FORMAT activity at Step B3.

If you have formatted all of your backup software, type N. CP/M will display:

A>

Now proceed to the DUP activity.

DUP

The DUP utility copies all of the data from one disk to another disk of the exact same type.

To use DUP for duplicating the data from the Distribution Disk, your Backup Disk must be the same size, and formatted to the same density, and number of sides.

The Distribution Disk (or Distribution Disk I) should be in drive A:
and the Backup Disk (or Backup Disk I) in drive B:.

1. At the A> prompt, type **DUP** and press **RETURN**. DUP will display the following:

```
Disk Utility Program  
Version 2.04
```

```
Do you want to:
```

```
A copy and verify  
B copy only  
C verify only
```

```
Z exit to operating system
```

```
Selection:
```

2. Type **A**. DUP will display:

```
Source unit:
```

3. Type **A**. DUP will display:

```
Destination unit:
```

4. Type **B**. DUP will display:

```
Put source disk in drive A.  
Put destination disk in drive B.
```

```
Press RETURN to begin:
```

5. Making certain that your disks are in the proper drives, press **RETURN**. DUP will copy the entire contents of your Distribution Disk onto your Backup Disk, as the lights on drives A and B glow alternately. Then DUP will display:

```
Copy finished.
```

After copying, DUP will automatically start to test the accuracy of the copy operation, as the glowing drive lights alternate more rapidly. When finished, DUP will display:

```
Verification finished.
```

Then DUP will redisplay the selection menu.

6. If you have duplicated all of your distribution software, proceed to Step 7.

If you have not yet duplicated all of your Distribution Disks, then insert a different Distribution Disk in drive A, and insert a different Backup Disk in drive B. Then resume the DUP activity at Step 2.

7. Type **Z** at the DUP selection menu. If you have more than one backup disk, DUP will display the following prompt:

Place a bootable disk in drive A and type any character:

8. Insert the Backup Disk (or Backup Disk I) in drive A, and type any keyboard character. Use your backup software for upcoming activities. CP/M will display the system prompt, as shown:

A>

9. Store your distribution software away in a safe place.

After completing the DUP activity, proceed to the text titled "Customizing Procedures".

Backup Procedure Three

Two or Three, Primary, 96 TPI, 5.25-inch, Floppy, Disk Drives

This procedure is used to construct a CP/M Backup Disk by copying both the CP/M Operating System and the utility files from your three CP/M Distribution Disks to a single blank disk.

Although your CP/M distribution software is recorded on 48 TPI (40 track) disks, you should use a 96 TPI (80 track) disk for the CP/M Backup Disk. Prepare for this procedure by labelling the 5.25-inch, 96 TPI, soft-sectored, blank disk as "CP/M Backup Disk".

NOTE: The blank disk that you will convert into a Backup Disk must be write enabled during all of the activities in this procedure. Therefore, do **not** cover the notch on the Backup Disk with a write-protect tab.

PROCEDURE SYNOPSIS

This procedure requires you to perform the following activities in sequence:

```
bootup
CONFIGUR
FORMAT
SYSGEN
PIP
```

To begin Procedure Three, insert CP/M Distribution Disk I in drive A and the Backup Disk in drive B. Then boot up to drive A. The CONFIGUR utility will be invoked automatically. Proceed to the CONFIGUR activity.

CONFIGUR

This CONFIGUR activity customizes the operating system that you placed in memory when you booted up so that you can copy data to your Backup Disk.

1. When the CONFIGUR activity is automatically invoked, it will display several messages. Wait for CONFIGUR to display the following message:

```
STANDARD SYSTEM (Y OR N)? <Y>:
```

2. Type the sequence of keyboard entries listed in Table 1-4. To the right of each entry is an excerpt or description of the part of the display that should appear immediately **after** you type the entry.

Keyboard Entries	Excerpt or Description of Desired Display
N	CP/M CONFIGURATION (Main Menu)
B	5.25 INCH SOFT-SECTORED UNIT 0 STEP RATE: 30MS TRACK DENSITY: 48TPI
B	5.25 INCH SOFT-SECTORED UNIT 1 STEP RATE: 30MS TRACK DENSITY: 48TPI
B	SOFT SECTOR UNIT 1 STEP RATE ?
6	SOFT SECTOR UNIT 1 STEP RATE ? 6
RETURN	SOFT SECTOR UNIT 1 TRACK DENSITY ?
96	SOFT SECTOR UNIT 1 TRACK DENSITY ? 96
RETURN	5.25 INCH SOFT-SECTORED UNIT 0 STEP RATE: 30MS TRACK DENSITY: 48TPI
Y	5.25 INCH SOFT-SECTORED UNIT 1 STEP RATE: 6MS TRACK DENSITY: 96TPI
X	CP/M CONFIGURATION (Main Menu) A> (CP/M system prompt)

Table 1-4
CONFIGUR Entries for 96 TPI Drives

NOTE: If the display excerpted or described in Table 1-4 does not appear, read the CONFIGUR text in Volume II: "The CP/M Reference Guide".

After you type this entry sequence, CP/M should display the A> system prompt. When the A> system prompt appears, proceed to the **FORMAT** activity.

FORMAT

This **FORMAT** activity prepares your Backup Disk for data storage.

1. After the CP/M prompt A>, type **FORMAT** and press **RETURN**. This entry invokes **FORMAT**, which displays a message in the form:

```
Format Version 2.04
This program is used to initialize a disk.
All information currently on the disk will be destroyed.
Is that what you want? (y/n):
```

2. Type **Y**. **FORMAT** will display:

```
Which drive do you wish to use for this operation?
```

3. Type **B**. **FORMAT** will display the prompt:

```
Which density? (S=single, D=double):
```

4. Type **D**. **FORMAT** will display the prompt:

```
Number of sides? (1=single, 2=double):
```

5. Type **2**. **FORMAT** will display the message:

```
96 TPI drive -- 80 tracks will be formatted
```

```
Put the disk you wish to be formatted in drive B.
Press RETURN to begin, anything else to abort.
```

NOTE: If the message does not indicate "96 TPI drive" and "80 tracks", then reset the computer and start over at the beginning of Backup Procedure Three.

6. Make sure that the Backup Disk is properly situated in drive B, and press **RETURN**. The light on the disk drive will glow for several seconds. Then **FORMAT** will display:

```
Do you have more disks to format? (y/n):
```

7. Type **N** and CP/M will display the **A>** system prompt.

Proceed to the SYSGEN activity.

SYSGEN

This SYSGEN activity will help you to copy the CP/M Operating System to the Backup Disk. Perform this activity with Distribution Disk I in drive A, and the Backup Disk in drive B.

1. At the **A>** prompt, type **SYSGEN** and press **RETURN**. This entry invokes SYSGEN, which displays a message in the following form:

```
SYSGEN VER 2.0.04
SOURCE DRIVE NAME (OR RETURN TO SKIP):
```

2. Type **A**. SYSGEN will display:

```
SOURCE ON A, THEN TYPE RETURN
```

3. Press **RETURN**. SYSGEN will display:

```
FUNCTION COMPLETE.
COPY BIOS.SYS (Y/N):
```

4. Type **Y**. SYSGEN will display:

```
FUNCTION COMPLETE
DESTINATION DRIVE NAME (OR RETURN TO REBOOT):
```

5. Type **B**. SYSGEN will display:

```
DESTINATION ON B, THEN TYPE RETURN
```

6. Press **RETURN**. SYSGEN will display:

```
FUNCTION COMPLETE.
DESTINATION DRIVE NAME (OR RETURN TO REBOOT):
```

7. Press **RETURN**. CP/M will display:

```
A>
```

Leave CP/M Distribution Disk I in drive A and the CP/M Backup Disk in drive B, and proceed to the PIP activity.

PIP

The PIP utility will help you to copy files from your CP/M Distribution Disks to your Backup Disk. The method you use to operate PIP depends on the number of 5.25-inch disk drives you have in your primary drive group. Use only one of the two PIP methods specified below:

If you have two primary 5.25-inch, disk drives, then use PIP Method A and follow the numbered steps preceded by the letter A.

If you have three primary 5.25-inch, disk drives, then use PIP Method B and follow the numbered steps preceded by the letter B.

Method A

A1. At the A> prompt, type the following command:

A>PIP B:=A:*. *[V] RETURN

(*.* is an ambiguous or wildcard file name that stands for all of the files on Distribution Disk I.) PIP will begin to copy the files from Distribution Disk I one by one, and display the name of each file in the form:

COPYING -
FILENAME.EXT

When PIP has finished copying the files, CP/M will redisplay the A> system prompt.

A2. Type the following command at the A> system prompt.

A>PIP B:=C:*. *[V] RETURN

(*.* is an ambiguous or wildcard file name that stands for all of the files on Distribution Disk II.) PIP will display the following prompt:

PUT DISK C IN DRIVE A: AND PRESS RETURN

- A3. Insert Distribution Disk II (temporarily called "DISK C") into drive A and press **RETURN**. The lights on the two 5.25-inch drives will glow alternately as PIP displays the names of the files it is copying in the following form:

```
COPYING -  
FILENAME.EXT
```

When PIP is finished copying all of the files from Distribution Disk II, the following prompt will be displayed:

```
PUT DISK A IN DRIVE A: AND PRESS RETURN
```

- A4. Insert Distribution Disk I (temporarily called "DISK A") into drive A and press **RETURN**. CP/M will display the A> system prompt.
- A5. Type the following command at the A> system prompt.

```
A>PIP B: = C:*. *[V] RETURN
```

(*.* is an ambiguous or wildcard file name that stands for all of the files on Distribution Disk III.) PIP will display the following prompt:

```
PUT DISK C IN DRIVE A: AND PRESS RETURN
```

- A6. Insert Distribution Disk III (temporarily called "DISK C") into drive A and press **RETURN**. The lights on the two 5.25-inch drives will glow alternately as PIP displays the names of the files it is copying in the following form:

```
COPYING -  
FILENAME.EXT
```

When PIP is finished copying all of the files from Distribution Disk III, the following prompt will be displayed:

```
PUT DISK A IN DRIVE A: AND PRESS RETURN
```

- A7. Insert Distribution Disk I (temporarily called "DISK A") into drive A and press **RETURN**. CP/M will display the A> system prompt.
- A8. Store your CP/M Distribution Disks in a safe place, and use your CP/M Backup Disk for upcoming activities.

After completing the PIP activity, proceed to the text titled "Customizing Procedures".

Method B

- B1. At the A> prompt, type the following command:

A>PIP B: = A:*. *[V] RETURN

(*.* is an ambiguous or wildcard file name that stands for all of the files on Distribution Disk I.) PIP will begin to copy the files from Distribution Disk I one by one, and display the name of each file in the form:

COPYING -
FILENAME. EXT

When PIP has finished copying the files, CP/M will redisplay the A> system prompt.

- B2. Insert Distribution Disk II in drive C.
- B3. Type the following command at the A> system prompt:

A>PIP B: = C:*. *[v]

(*.* is an ambiguous or wildcard file name that stands for all of the files on Distribution Disk II.) PIP will begin to copy the files from Distribution Disk II one by one, and display the name of each file in the form:

COPYING -
FILENAME. EXT

When PIP has finished copying the files, CP/M will redisplay the A> system prompt.

- B4. Remove Distribution Disk II from drive C and insert Distribution Disk III in drive C.

B5. Type the following command at the A> system prompt:

```
A>PIP B:=C:*. *[v]
```

(*.* is an ambiguous or wildcard file name that stands for all of the files on Distribution Disk III.) PIP will begin to copy the files from Distribution Disk III one by one, and display the name of each file in the form:

```
COPYING -  
FILENAME.EXT
```

When PIP has finished copying the files, CP/M will redisplay the A> system prompt.

After completing the PIP activity, proceed to the text titled "Customizing Procedures".

Backup Procedure Four

One Primary, 96 TPI, 5.25-inch, Floppy, Disk Drive and One or Two 48 TPI, 5.25-inch, Floppy, Disk Drive(s)

This procedure is used to construct a CP/M Backup Disk by copying both the CP/M Operating System and the utility files from your three CP/M Distribution Disks to a single blank disk.

Although your CP/M distribution software is recorded on 48 TPI (40 track) disks, you should use a single 96 TPI (80 track) disk for the CP/M Backup Disk. Prepare for this procedure by labelling the 5.25-inch, 96 TPI, soft-sectored, blank disk as "CP/M Backup Disk".

The blank disk that you will convert into a Backup Disk must be write enabled during all of the activities in this procedure. Therefore, do **not** cover the notch on the Backup Disk with a write-protect tab.

NOTE: Backup Procedure Four does not specify all of the drive letters that you must include in the command lines you enter. Therefore, before you enter these command lines, you must determine the drive letters that will correspond to the physical drive units in your primary drive group.

PROCEDURE SYNOPSIS

This procedure requires you to perform the following activities in sequence:

bootup
CONFIGUR
FORMAT
SYSGEN
PIP

To begin Backup Procedure Four, insert CP/M Distribution Disk I in a 48 TPI drive, and the Backup Disk in the 96 TPI drive. Then boot up to the 48 TPI drive containing CP/M Distribution Disk I. The CONFIGUR utility will be invoked automatically. Proceed to the CONFIGUR activity.

CONFIGUR

This CONFIGUR activity customizes the operating system that you placed in memory when you booted up so that you can copy data to your Backup Disk.

1. When the CONFIGUR activity is automatically invoked, it will display several messages. Wait for CONFIGUR to display the following message:

STANDARD SYSTEM (Y OR N)? <Y>:

2. Type **N** at the "STANDARD SYSTEM" prompt. CONFIGUR will display the "CP/M CONFIGURATION" menu.
3. Type **B** at the "SELECTION" prompt beneath the "CP/M CONFIGURATION" menu. CONFIGUR will display the disk parameters menu (submenu B), showing the status of your 5.25-inch drive units.
4. Select the "SOFT-SECTORED UNIT" that corresponds to your 96 TPI primary drive. CONFIGUR will prompt you to enter a "STEP RATE".
5. Type **6** for the step rate of your 96 TPI primary drive. (This entry is necessary to change the 30 ms default step rate.) CONFIGUR will prompt you to enter a "TRACK DENSITY".

6. Type **96** for the track density of your 96 TPI primary drive. (This entry is necessary to change the 48 TPI default track density.) CONFIGUR will display the changed status of your 96 TPI drive.
7. Type **Y** at the "SELECTION" prompt beneath the drive disk parameters menu (submenu B). CONFIGUR will redisplay the "CP/M CONFIGURATION" menu.
8. Type **X** at the "SELECTION" prompt beneath the "CP/M CONFIGURATION" menu. CP/M will display the system prompt.

Proceed to the FORMAT activity.

FORMAT

This FORMAT activity prepares your Backup Disk for data storage.

1. After the CP/M prompt A>, type **FORMAT** and press **RETURN**. This entry invokes FORMAT, which displays a message in the form:

```
Format Version 2.04
This program is used to initialize a disk.
All information currently on the disk will be destroyed.
Is that what you want? (y/n):
```

2. Type **Y**. FORMAT will display:

Which drive do you wish to use for this operation?
3. Type the drive letter that corresponds to your 96 TPI drive. FORMAT will display the prompt:

```
Which density? (S=single, D=double):
```

4. Type **D**. FORMAT will display the prompt:

```
Number of sides? (1=single, 2=double):
```

5. Type **2**. **FORMAT** will display the message:

96 TPI drive -- 80 tracks will be formatted

Put the disk you wish to be formatted in drive x.
Press **RETURN** to begin, anything else to abort.

NOTE: If the message does not indicate "96 TPI drive" and "80 tracks", then reset the computer and go back to the beginning of Backup Procedure Four and start over.

6. Make sure that the Backup Disk is properly situated in the 96 TPI drive, and press **RETURN**. The light on the disk drive will glow for several seconds. Then **FORMAT** will display:

Do you have more disks to format? (y/n):

7. Type **N** and **CP/M** will display the **A>** system prompt.

Proceed to the **SYSGEN** activity.

SYSGEN

This **SYSGEN** activity will help you to copy the **CP/M** Operating System to the Backup Disk. Perform this activity with Distribution Disk I in the 48 TPI drive you used to boot up (drive **A**), and the Backup Disk in the 96 TPI drive.

1. At the **A>** prompt, type **SYSGEN** and press **RETURN**. This entry invokes **SYSGEN**, which displays a message in the following form:

SYSGEN VER 2.0.04
SOURCE DRIVE NAME (OR RETURN TO SKIP):

2. Type **A**. **SYSGEN** will display:

SOURCE ON A, THEN TYPE RETURN

3. Press **RETURN**. **SYSGEN** will display:

FUNCTION COMPLETE.
COPY BIOS.SYS (Y/N):

4. Type **Y**. SYSGEN will display:

FUNCTION COMPLETE
DESTINATION DRIVE NAME (OR RETURN TO REBOOT):

5. Type the drive letter that corresponds to your 96 TPI drive. SYSGEN will display:

DESTINATION ON B, THEN TYPE RETURN

6. Press **RETURN**. SYSGEN will display:

FUNCTION COMPLETE.
DESTINATION DRIVE NAME (OR RETURN TO REBOOT):

7. Press **RETURN**. CP/M will display:

A>

Leave CP/M Distribution Disk I in the 48 TPI drive you used to boot up (drive A), leave the Backup Disk in the 96 TPI drive, and proceed to the PIP activity.

PIP

This PIP activity will help you to copy files from your CP/M Distribution Disks to your Backup Disk. The method you use to operate PIP depends on the number of 5.25-inch disk drives you have in your primary drive group. Use only one of the two PIP methods specified below:

If you have two primary 5.25-inch, disk drives, (one 96 TPI and one 48 TPI) then use PIP Method A and follow the numbered steps preceded by the letter A.

If you have three primary 5.25-inch, disk drives, (one 96 TPI and two 48 TPI) then use PIP Method B and follow the numbered steps preceded by the letter B.

Method A

- A1. At the A> prompt, type the following command:

A>**PIP x: = A:*. *[V] RETURN**

Where **x** stands for the drive letter that references the Backup Disk within the 96 TPI drive;

where **A** is the drive letter that references Distribution Disk I within the 48 TPI drive;

where ***.*** is an ambiguous or wildcard file name that stands for all of the files on Distribution Disk I; and

where **[V]** is an option that verifies the accuracy of this PIP activity.

PIP will begin to copy the files from Distribution Disk I one by one, and display the name of each file in the form:

```
COPYING -  
FILENAME.EXT
```

When PIP has finished copying the files, CP/M will redisplay the A> system prompt.

A2. Type a command in the following form at the A> system prompt:

```
A>PIP x: = y: *.* [V] RETURN
```

Where **x** stands for the drive letter that references the Backup Disk within the 96 TPI drive;

where **y** stands for the drive letter that references Distribution Disk II within the 48 TPI drive;

where ***.*** is an ambiguous or wildcard file name that stands for all of the files on Distribution Disk II; and

where **[V]** is an option that verifies the accuracy of this PIP activity.

When you enter a command in this form, a prompt in the following form will be displayed:

PUT DISK y IN DRIVE A: AND PRESS RETURN

- A3. Insert Distribution Disk II (temporarily called "DISK y") into the 48 TPI drive (drive A) and press **RETURN**. PIP will display the names of the files it is copying in the following form:

COPYING -
FILENAME.EXT

When PIP is finished copying all of the files from Distribution Disk II, the following prompt will be displayed:

PUT DISK A IN DRIVE A: AND PRESS RETURN

- A4. Insert Distribution Disk I (temporarily called "DISK A") into the 48 TPI drive (drive A) and press **RETURN**. CP/M will display the A> system prompt.
- A5. Type a command in the following form at the A> system prompt:

A>**PIP x:=y:*. *[V] RETURN**

Where **x** stands for the drive letter that references the Backup Disk within the 96 TPI drive;

where **y** stands for the drive letter that references Distribution Disk III within the 48 TPI drive;

where ****. *** is an ambiguous or wildcard file name that stands for all of the files on Distribution Disk III; and

where **[V]** is an option that verifies the accuracy of this PIP activity.

When you enter a command in this form, a prompt in the following form will be displayed:

PUT DISK y IN DRIVE A: AND PRESS RETURN

- A6. Insert Distribution Disk III (temporarily called "DISK C") into the 48 TPI drive (drive A) and press **RETURN**. PIP will display the names of the files it is copying in the following form:

```
COPYING -  
FILENAME.EXT
```

When PIP is finished copying all of the files from Distribution Disk III, the following prompt will be displayed:

```
PUT DISK A IN DRIVE A: AND PRESS RETURN
```

- A7. Insert Distribution Disk I (temporarily called "DISK A") into the 48 TPI drive (drive A) and press **RETURN**. CP/M will display the A> system prompt.
- A8. Store your CP/M Distribution Disks in a safe place, and use your CP/M Backup Disk for upcoming activities.

After completing the PIP activity, proceed to the text titled "Customizing Procedures".

Method B

- B1. At the A> prompt, type the following command:

```
A>PIP x: = A:*. *[V] RETURN
```

Where **x** stands for the drive letter that references the Backup Disk within the 96 TPI drive;

where **A** is the drive letter that references Distribution Disk I within the 48 TPI drive you used to boot up;

where ****. *** is an ambiguous or wildcard file name that stands for all of the files on Distribution Disk I; and

where **[V]** is an option that verifies the accuracy of this PIP activity.

PIP will begin to copy the files from Distribution Disk I one by one, and display the name of each file in the form:

```
COPYING -  
FILENAME.EXT
```

When PIP has finished copying the files, CP/M will redisplay the A> system prompt.

- B2. Insert Distribution Disk II in the 48 TPI drive that you did **not** use to boot up.
- B3. Type a command in the following form at the A> system prompt:

A>PIP x: = y:*.*[V] RETURN

Where **x** stands for the drive letter that references the Backup Disk within the 96 TPI drive;

where **y** stands for the drive letter that references Distribution Disk II within the 48 TPI drive you did **not** use to boot up;

where ***.*** is an ambiguous or wildcard file name that stands for all of the files on Distribution Disk II; and

where **[V]** is an option that verifies the accuracy of this PIP activity.

PIP will begin to copy the files from Distribution Disk II one by one, and display the name of each file in the form:

COPYING -
FILENAME.EXT

When PIP has finished copying the files, CP/M will redisplay the A> system prompt.

- B4. Remove Distribution Disk II from the 48 TPI drive that you did **not** use to boot up and insert Distribution Disk III in this drive.
- B5. Type a command in the following form at the A> system prompt:

A>PIP x: = y:*.*[V] RETURN

Where **x** stands for the drive letter that references the Backup Disk within the 96 TPI drive;

where **y** stands for the drive letter that references Distribution Disk III within the 48 TPI drive you did **not** use to boot up;

where ***.*** is an ambiguous or wildcard file name that stands for all of the files on Distribution Disk III; and

where **[V]** is an option that verifies the accuracy of this PIP activity.

PIP will begin to copy the files from Distribution Disk III one by one, and display the name of each file in the form:

```
COPYING -  
FILENAME.EXT
```

When PIP has finished copying the files, CP/M will redisplay the A> system prompt.

After completing the PIP activity, proceed to the text titled "Customizing Procedures".

Backup Procedure Five

An H/Z67 (Winchester Disk) Primary Drive

Use this procedure to back up an 8-inch Distribution Disk by copying both the CP/M Operating System and the utility files to a partition on the Winchester Disk. This partition will be known, for now, as the "Backup Partition".

Before beginning Backup Procedure Five, you should perform the Winchester Disk Partitioning Operation using the PART program. The PART program and its documentation are provided with your H/Z67 hardware.

NOTE: To enable you to copy data to a Winchester Disk partition, write-protect switch 0 (located on the front panel of the H/Z67 drive model) should be pressed down.

PROCEDURE SYNOPSIS

This procedure requires you to perform the following activities in sequence:

```
bootstrap
CONFIGUR
ASSIGN
FORMAT
SYSGEN
PIP
```

To begin Backup Procedure Five, insert your CP/M Distribution Disk into the floppy disk drive slot (right-hand slot) of the H/Z67 drive unit. Enter the bootup command necessary for booting-up to this floppy disk drive. This drive will be referred to as drive A: throughout this procedure. When the CONFIGUR utility is automatically invoked, wait for the "STANDARD SYSTEM" prompt and type Y.

Then proceed to the ASSIGN activity.

ASSIGN

The ASSIGN utility assigns H/Z-67 Winchester Disk partitions to drive names. Partitions should have already been created using the PART program (as described in the PART documentation). CP/M will allow one or two partitions to be assigned to drive names on the Winchester Disk. But during this procedure, you will assign only one partition to one drive name.

1. Type **ASSIGN ?** and press **RETURN**. ASSIGN will display a list of the partition names and occurrence numbers that were set up with the PART program. Such a display might look something like this:

PARTITION NAME	OCCUR	SIZE
-----	----	-----
CPM	; 0	3200k
CPM	; 1	2860k
CPM	; 2	2020k
HDOS	; 0	1600k

Your partitions will probably have different names and numbers, though they will be displayed in this form.

2. Select the partition that you want to become your Backup Partition.
3. Type **ASSIGN B: = {partition name};{n}** and press **RETURN**.

Where **{partition name}** is a variable used to represent the name of the partition you select; and

where **{n}** is a variable used to represent the occurrence number of the partition you select.

A partition's name and occurrence number must be separated by a semicolon (;). Hence, a sample entry would be **ASSIGN B:CPM;2**.

4. If you wish to confirm the assignment, type **ASSIGN** and press **RETURN**. The ASSIGN utility will display the drive assignment you just entered. A sample display might appear as shown:

B: = CPM;2

Leave your Distribution Disk in drive A: and proceed to the FORMAT activity.

FORMAT

The FORMAT utility will prepare the Backup Partition on your Winchester Disk for data storage.

1. After the CP/M prompt **A>**, type **FORMAT** and press **RETURN**. This entry invokes FORMAT, which will display the following message:

```
Format Version 2.04
This program is used to initialize a disk.
All information currently on the disk will be destroyed.
Is that what you want? (y/n):
```

2. Type **Y**. FORMAT will display:

Which drive do you wish to use for this operation?

3. Type **B**. FORMAT will display:

Press RETURN to begin.

4. Press **RETURN**. FORMAT will begin preparing the surface of the partition (drive B:), and display the following message:

```
FORMATTING PARTITION
```

When finished with its task, FORMAT displays the message:

```
Do you have more disks to format? (y/n):
```

5. Type **N**. CP/M will display:

```
A>
```

Leave the Distribution Disk in the floppy disk drive slot and proceed to the SYSGEN activity.

SYSGEN

The SYSGEN utility puts a copy of the CP/M Operating System on your Backup Partition (drive B:). SYSGEN will get this Operating System copy from the Distribution Disk.

1. At the A> prompt, type **SYSGEN** and press **RETURN**. This entry invokes SYSGEN, which will display a message in the following form:

```
SYSGEN VERSION 2.0.04
SOURCE DRIVE NAME (OR RETURN TO SKIP):
```

2. Type **A**. SYSGEN will display:

```
SOURCE ON A, THEN TYPE RETURN
```

3. Press **RETURN**. SYSGEN will display:

```
FUNCTION COMPLETE
COPY BIOS.SYS (Y/N):
```

4. Type **Y**. SYSGEN will respond:

```
FUNCTION COMPLETE
DESTINATION DRIVE NAME (OR RETURN TO REBOOT):
```

5. Type **B**. SYSGEN will display:

```
DESTINATION ON B, THEN TYPE RETURN
```

6. Press **RETURN**. SYSGEN will display:

```
FUNCTION COMPLETE
DESTINATION DRIVE NAME (OR RETURN TO REBOOT):
```

7. Press **RETURN**. Now CP/M will display the system prompt:

```
A>
```

Leave the Distribution Disk in the floppy disk drive slot and proceed to the PIP utility.

PIP

You will use the PIP utility to copy all of the files from your Distribution Disk to your Backup Partition.

1. At the A> prompt, type **PIP** and press **RETURN**. PIP will display the asterisk prompt (*).
2. At the asterisk (*) prompt, type the following command:

```
B:=A:*.*
```

Where ***.*** is an ambiguous (wildcard) file name that stands for all of the files on the Distribution Disk in drive A.

PIP will display the explicit name of each file from drive A: as it copies the file. This display takes the following form:

```
COPYING -
FILE1.EXT
FILE2.EXT
FILE3.EXT
```

3. When PIP finishes copying all of the displayed files, it will redisplay the asterisk (*) prompt. Press **RETURN** at the asterisk (*) prompt. Then CP/M will display the system prompt, as shown:

```
A>
```

When you have completed the PIP activity, proceed to the text titled "Customizing Procedures".

NOTE: If you would like to copy the data from the Backup Partition (or any partition) to an 8-inch floppy disk, use the BRS utility as explained in the text titled "BRS" in Volume II: The CP/M Reference Guide.

CUSTOMIZING PROCEDURES

The CP/M Operating System on your Distribution Disk and Backup Disk is already set to control some of the components of your hardware environment in a limited fashion. These customization procedures will help you to make some changes to the CP/M Operating System so that it will control all of the components of your hardware environment at peak efficiency.

The product of these procedures* will be a disk containing a fully customized copy of the CP/M Operating System. We will call this disk the "System Disk", because for now it will contain only the CP/M system kernel and the CP/M file BIOS.SYS. ("Working Disk Procedures" will instruct you to add other useful files to this disk later on.)

Because Heath/Zenith offers such a wide range of hardware devices, different users require different procedures for customizing CP/M. Therefore, this section contains six different procedures for customizing a CP/M Operating System. You will need to use one of these procedures now, and whenever you add devices to your hardware environment.

The procedure you use to customize your operating system depends mainly upon your assortment of disk drives. Use Table 1-5 to determine the proper procedure.

Table 1-5 lists groups of disk drives offered by Heath/Zenith. Every user of Heath/Zenith disk drives has either one or two drive groups. The "primary drive group" is the group of drives that you use to perform bootstrap with your CP/M Distribution Disk(s) and your CP/M Backup Disk(s). The "secondary drive group" consists of drives of a different type which are not accessible through your CP/M distribution software.

To use Table 1-5, locate the intersection of the line that describes your primary drive group and the column that describes your secondary drive group (if any). At the point of intersection is the number of the customization procedure you should use.

* Customizing Procedures Three and Six help you to customize the operating system that already resides on a Backup Partition or Backup Disk, rather than preparing an additional partition or disk to receive the customized operating system.

SECONDARY DRIVE GROUP

P R I M A R Y D R I V E G R O U P	NO SECONDARY DRIVE GROUP	One 48 TPI, 5.25-inch drive	One 96 TPI, 5.25-inch drive	Two 48 TPI, 5.25-inch drives	Three 48 TPI, 5.25-inch drives	Two 48 TPI, 8-inch drives (H-47 or Z-47)	Two 96 TPI, 5.25-inch drives	Two 96 TPI, 5.25-inch drives and one 48 TPI, 5.25-inch drive	Three 96 TPI, 5.25-inch drives	One 96 TPI, 5.25-inch drive and one 48 TPI, 5.25-inch drive	One 96 TPI, 5.25-inch drive and two 48 TPI, 5.25-inch drives	One Winchester/floppy drive (H-67 or Z-67)	
	One 48 TPI, 5.25-inch drive	1	4	4	4	4	4	4	4	4	4	4	4
	One 96 TPI, 5.25-inch drive	1	4		4	4	4						4
	Two 48 TPI, 5.25-inch drives	2	5	5	5	5	5	5	5	5	5	5	5
	Three 48 TPI, 5.25-inch drives	2	5	5	5	5	5	5	5	5	5	5	5
	Two 48 TPI, 8-inch drives (H-47 or Z-47)	2	5	5	5	5		5	5	5	5	5	5
	Two 96 TPI, 5.25-inch drives	2	5		5	5	5						5
	Two 96 TPI, 5.25-inch drives and one 48 TPI, 5.25-inch drive	2	5		5	5	5						5
	Three 96 TPI, 5.25-inch drives	2	5		5	5	5						5
	One 96 TPI, 5.25-inch drive and one 48 TPI, 5.25-inch drive	3	6		6	6	6						6
	One 96 TPI, 5.25-inch drive and two 48 TPI, 5.25-inch drives	3	6		6	6	6						6
	One Winchester/floppy drive (H-67 or Z-67)	3	6	6	6	6	6	6	6	6	6	6	

Table 1-5
Customizing Procedures

- * Customizing Procedure One begins on page 1-96
- * Customizing Procedure Two begins on page 1-114
- * Customizing Procedure Three begins on page 1-132
- * Customizing Procedure Four begins on page 1-145
- * Customizing Procedure Five begins on page 1-169
- * Customizing Procedure Six begins on page 1-190

When you've found the appropriate procedure, turn to the pages explaining your procedure and follow the step-by-step instructions for this procedure. If you feel that you can perform the activities without step-by-step instructions, then you can use the "Procedure Synopsis" at the beginning of the procedure for an overview of the activities involved.

Customizing Procedure One

One Primary 5.25-inch Floppy Drive, and No Secondary Drives

This procedure will help you to customize a copy of the CPM Operating System taken from your Backup Disk (or Backup Disk I), and put this customized system copy on a blank disk. The blank disk must be manufactured the same type as the Backup Disk, Label this blank disk as the "System Disk". The System Disk must be write enabled during this procedure.

PROCEDURE SYNOPSIS

This procedure requires you to perform the following activities in sequence:

```
bootup
CONFIGUR
FORMAT
MOVCPM*
SYSGEN
bootstrap
PIP
bootstrap
CONFIGUR
```

To begin Procedure One, insert Backup Disk I into the disk drive. Boot up. The CONFIGUR utility will be invoked automatically. Proceed to the CONFIGUR activity.

* Use either MOVCPM17 or MOVCPM37.

CONFIGUR

This CONFIGUR activity customizes the operating system that you placed in memory when you performed bootstrap so that you can copy data to your backup disk(s). There are two methods for performing this CONFIGUR activity, so use **ONLY** the method specified below for your primary drive group.

If your primary drive (the one used for bootstrap) is a 48 TPI drive, then use Method A for this CONFIGUR activity.

If your primary drive (the one used for bootstrap) is a 96 TPI drive, then use Method B for this CONFIGUR activity.

Method A

When the CONFIGUR utility is automatically invoked, it will display several messages. When CONFIGUR displays the message:

```
STANDARD SYSTEM (Y OR N)? <Y>:
```

type **Y**. The CONFIGUR activity will end, and CP/M will display the **A>** system prompt.

Proceed to the FORMAT activity.

Method B

When the CONFIGUR utility is automatically invoked, it will display several messages. When CONFIGUR displays the message:

```
STANDARD SYSTEM (Y OR N)? <Y>:
```

type the sequence of keyboard entries listed in Table 1-6. To the right of each entry is an excerpt or description of the part of the display that should appear immediately **after** your entry.

Keyboard Entries	Excerpt or Description of Desired Display
N B A 6 RETURN 96 RETURN Y D A Y Y	CP/M CONFIGURATION (Main Menu) 5.25 INCH SOFT-SECTORED UNIT 0 STEP RATE: 30MS TRACK DENSITY: 48TPI SOFT-SECTOR UNIT 0 STEP RATE ? SOFT-SECTOR UNIT 0 STEP RATE ? 6 SOFT-SECTOR UNIT 0 TRACK DENSITY ? SOFT-SECTOR UNIT 0 TRACK DENSITY ? 96 5.25 INCH SOFT-SECTORED UNIT 0 STEP RATE: 6MS TRACK DENSITY: 96TPI CP/M CONFIGURATION (Main Menu) RUN AUTOMATIC COMMAND LINE ON COLD BOOT: TRUE RUN AUTOMATIC COMMAND LINE ON COLD BOOT: FALSE CP/M CONFIGURATION (Main Menu) A> (CP/M system prompt)

Table 1-6
CONFIGUR Entries for One 96 TPI Drive

When the A> system prompt appears, proceed to the FORMAT activity.

NOTE: If the display excerpted or described in the table does not appear, read the CONFIGUR text in "Volume II: The CP/M Reference Guide".

Proceed to the FORMAT activity.

FORMAT

Use the FORMAT utility to prepare a System Disk for data storage. The method you should use to operate FORMAT depends on the type of System Disk you are preparing. Use only one of the two FORMAT methods specified below:

If your System Disk is hard-sectored, use Method A to FORMAT and follow the numbered steps preceded by the letter A.

If your System Disk is soft-sectored, use Method B to FORMAT and follow the numbered steps preceded by the letter B.

Method A:

- A1. At the A> system prompt, type **FORMAT** and press **RETURN**. This entry invokes **FORMAT**, which displays a message in the following form:

```
Format Version 2.04
This program is used to initialize a disk.
All information currently on the disk will be destroyed.
Is that what you want? (y/n):
```

- A2. Type **Y**. **FORMAT** will display:

```
Which drive do you wish to use for this operation?
```

- A3. Type **A**. **FORMAT** will display:

```
Put the disk you wish to be formatted in drive A.
Press RETURN to begin, anything else to abort.
```

- A4. Remove Backup Disk I, and insert the System Disk. Then close the drive and press **RETURN**.

- A5. The light on the disk drive will glow for several seconds. Then **FORMAT** will display:

```
Do you have more disks to format? (y/n):
```

- A6. Type **N** and **FORMAT** will display:

```
Place a bootable disk in drive A and press any character.
```

- A7. Remove the System Disk and insert Backup Disk in the drive. Then type any character. **CP/M** will display:

```
A>
```

Leave the Backup Disk in the drive and proceed to the **MOVCPM** activity.

Method B:

- B1. At the A> System Prompt, type **FORMAT** and press **RETURN**. This entry invokes FORMAT, which displays the following:

```
Format Version 2.04
This program is used to initialize a disk.
All information currently on the disk will be destroyed.
Is that what you want? (y/n):
```

- B2. Type **Y**. FORMAT will display:

```
Which drive do you wish to use for this operation?
```

- B3. Type **A**. FORMAT will display:

```
Which density? (S=single, D=double):
```

- B4. If your System Disk is a single-density disk, type **S**.

If your System Disk is a double-density disk, type **D**.

After you respond to the density prompt, FORMAT will display:

```
Number of sides? (1=single, 2=double):
```

- B5. If your System Disk is a single-sided disk, type **1**.

If your System Disk is a double-sided disk, type **2**.

After you respond to the side quantity prompt, FORMAT will display one of the following two messages:

```
48 TPI drive-- 40 tracks will be formatted
```

or

```
96 TPI drive -- 80 tracks will be formatted
```

(If the type of TPI drive specified here is different from your drive, repeat the previous CONFIGUR activity.) FORMAT will also display the following prompt:

```
Put the disk you wish to be formatted in drive A.
Press RETURN to begin, anything else to abort.
```

B6. Immediately remove the Backup Disk (or Backup Disk I) and insert the System Disk. Then close the disk drive, and press **RETURN**.

B7. The light on the disk drive will glow for several seconds. Then FORMAT will display:

Do you have more disks to format? (y/n):

B8. Type N, and FORMAT will display:

Place a bootable disk in drive A and press any character:

B9. Remove the System Disk and insert the Backup Disk (of Backup Disk I). Then type any character. CP/M will display:

A>

With the Backup Disk (or Backup Disk I) in the drive, proceed to the MOVCPM activity.

MOVCPM

The MOVCPM utilities enable you to adjust the amount of memory space that your CP/M Operating System will occupy in your microcomputer. Your computer has a memory limit of either 32K, 48K, or 64K. However, the operating system on your Backup Disk is preset to occupy only 32K. ("K" stands for kilobyte, a unit of data storage space.)

MOVCPM loads part of the operating system into a special location in computer memory, and allows it to expand until it fills the computer's entire memory capacity.

If your computer's memory limit is 32K, then skip the MOVCPM activity and proceed to the instructions for the SYSGEN activity (Method B).

If the memory limit "nn" indicated in the bootstrap message ("nnK HEATH/ZENITH CP/M v.v.vv") is smaller than the your computer's limit, then use one of the MOVCPM utilities to raise the memory limit on your operating system, so that it matches that of your computer.

NOTE: If you don't use a MOVCPM utility to take advantage of all of your computer's available memory space, you will not be able to use application programs that require more than 32K of memory space.

1. If the disk that you just formatted is hard-sectored, then enter the following command in response to the system prompt:

A>MOVCPM17

If the disk that you just formatted is soft-sectored, then enter the following command in response to the system prompt:

A>MOVCPM37

2. Wait for the MOVCPM utility to display a message in the following form:

MOVCPMdd Version 2.2.04

CONSTRUCTING 64k CP/M vers 2.2

READY FOR "SYSGEN" OR

"SAVE 38 CPMnn.COM"

Your display may differ in numeric values, depending on which version of MOVCPM you used and how much memory space it found in your computer.

Proceed immediately to the SYSGEN activity.

SYSGEN

The SYSGEN utility copies some or all of the CP/M Operating System onto your System Disk. SYSGEN might get this operating system copy from the Backup Disk, or from a special location in computer memory (if a MOVCPM activity put part of the operating system in this special memory location).

If you just performed a MOVCPM operation, use SYSGEN Method A and follow the numbered steps preceded by the letter A.

If the memory limit indicated in the bootstrap message ("nnK HEATH/ZENITH CP/M v.v.vv") matches the actual memory limit of your micro-computer, then use SYSGEN Method B and follow the numbered steps preceded by the letter B.

Method A:

- A1. At the A> prompt, type **SYSGEN** and press **RETURN**. This entry invokes the SYSGEN utility, which displays a message in the form:

```
SYSGEN VER 2.2.04
SOURCE DRIVE NAME (OR RETURN TO SKIP): RETURN
```

- A2. Press **RETURN** as shown above. SYSGEN will display:

```
DESTINATION DRIVE NAME (OR RETURN TO REBOOT):
```

- A3. Type **B**. SYSGEN will display:

```
DESTINATION ON B, THEN TYPE RETURN
```

- A4. Type **RETURN**. SYSGEN will display the following prompt:

```
PUT DISK B IN DRIVE A: AND PRESS RETURN
```

- A5. Remove the Backup Disk and insert your System Disk. Then press **RETURN**. SYSGEN will display:

```
FUNCTION COMPLETE.
DESTINATION DRIVE NAME (OR RETURN TO REBOOT):
```

- A6. Reset the computer. Do not press **RETURN** at this prompt. Then remove the System Disk, insert the Backup Disk, and perform bootstrap. CP/M will display the system prompt:

```
A>
```

Leave the Backup Disk in the drive and proceed to the PIP activity.

Method B

- B1. At the A> prompt, type **SYSGEN** and press **RETURN**. This entry invokes SYSGEN, which displays a message in the following form:

```
SYSGEN VER 2.2.04
SOURCE DRIVE NAME (OR RETURN TO SKIP):
```

- B2. Type **A**. SYSGEN will display:

```
SOURCE ON A, THEN TYPE RETURN
```

B3. Press **RETURN**. SYSGEN will display:

FUNCTION COMPLETE.
COPY BIOS.SYS (Y/N):

B4. Type **Y**. SYSGEN will display:

FUNCTION COMPLETE
DESTINATION DRIVE NAME (OR RETURN TO REBOOT):

B5. Type **B**. SYSGEN will display:

DESTINATION ON B, THEN TYPE RETURN

B6. Press **RETURN**. SYSGEN will display the following prompts:

PUT DISK B IN DRIVE A: AND PRESS RETURN

B7. Remove the Backup Disk, insert the System Disk, and press **RETURN**. SYSGEN will display:

FUNCTION COMPLETE.
DESTINATION DRIVE NAME (OR RETURN TO REBOOT):

B8. Press **RETURN**. SYSGEN will display the following prompt:

PUT DISK A IN DRIVE A: AND PRESS RETURN

B9. Press **RETURN**. CP/M will display:

A>

Insert the System Disk in the drive, boot up, and proceed to CONFIGUR.

PIP

The PIP utility is used to copy files between disks. You will use it now to copy the BIOS.SYS file from your Backup Disk to your System Disk.

1. At the A> system prompt type the following command line:

A>**PIP B: = A:BIOS.SYS[R]**

Where **B:** represents the System Disk (the destination of the BIOS.SYS file);

where **A:** represents the Backup Disk (the source of the BIOS.SYS file);

where **BIOS.SYS** is the file component of the CP/M Operating System; and

where **[R]** is a command line parameter that allows you to copy a file that has Read/Only status (such as BIOS.SYS.)

2. For the remainder of this activity, PIP will prompt you to insert the Backup Disk and the System Disk alternately by displaying one of the following two prompts:

PUT DISK A IN DRIVE A: AND PRESS RETURN

OR

PUT DISK B IN DRIVE A: AND PRESS RETURN

Where "DISK A" is the Backup Disk; and
where "DISK B" is the System Disk.

When PIP has finished copying the BIOS.SYS file, CP/M will redisplay the A> system prompt.

3. At the A> system prompt, reset the computer.
4. Insert the System Disk and boot up to test this disk.

Leave the System Disk in the drive and proceed to the CONFIGUR activity.

CONFIGUR

The CONFIGUR utility customizes the operating system on your System Disk to match several characteristics of your hardware environment. This procedure will show you how to use CONFIGUR to customize the system for only essential hardware characteristics. (Use the CONFIGUR instructions in the Volume II: The CP/M Reference Guide if you want more detailed instructions on using CONFIGUR.)

To begin this activity, you should have your System Disk in the drive slot. Refer to the System Disk as "DISK A". Keep your Backup Disk (or Backup Disk I) handy and refer to it as "DISK B". Prompts will instruct you to alternately insert "DISK B" (Backup Disk) and "DISK A" (System Disk).

1. Type the command **B:CONFIGUR RETURN** at the system prompt. The terminal display will read:

```
PUT DISK B IN DRIVE A: AND PRESS RETURN
```

2. Remove the System Disk, insert Backup Disk I, and press **RETURN**. The terminal display will read:

```
PUT DISK A IN DRIVE A: AND PRESS RETURN
```

3. Remove Backup Disk I, insert the System Disk, and press **RETURN**. The CONFIGUR utility will present a display that begins with an identification message in the following form:

```
Heath/Zenith Configuration Program  
Version 2.2.04  
Serial Number: sss-sssss
```

CONFIGUR will continue to display messages, ending with the following prompt:

```
Standard system (Y or N)? <Y>:
```

4. Type **N**. CONFIGUR will display a selection menu labelled "CP/M Configuration".
5. Refer to Table 1-7 if you have a Z89-3 interface card, and to Table 1-8 if you have a Z89-11 interface card. Using the appropriate table, type the keyboard entries listed for your terminal. To the right of each entry is an excerpt or description of part of the display that should appear immediately **after** you type the entry. If the excerpted or described display in the table does not appear on your terminal, repeat the entry.

NOTE: Type only the capital letters or numbers featured in bold faced type beneath the heading "Keyboard Entries". Do not change the order of the entries listed. If you type an incorrect entry at a prompt, CONFIGUR will either ignore your mistake, or display it. If a mistake is

ignored, simply answer the prompt again. If CONFIGUR displays your mistake, you can usually change it by typing **Z** and repeating a few entries.

Your Terminal	Keyboard Entries	Excerpt or Description of Desired Display
Zenith or Heath Z-19, H-19, Z-88, H-88, Z-89, H-89, or Z-90 terminal	A A 9 350 Y C A CRT Y	(Terminal and Printer Characteristics – Submenu A) CRT: baud rate: CRT: baud rate: 9600 port: CRT: baud rate: 9600 port: 0E8H = 350Q CP/M Configuration (Main Menu) (Default I/O Configuration – Submenu C) CRT: = CON: = CRT: CP/M Configuration (Main Menu)
DECwriter LA-34 or LA-36 terminal	A B 30 320 Y C A TTY Y	(Terminal and Printer Characteristics – Submenu A) TTY: baud rate: TTY: baud rate: 300 port: TTY: baud rate: 300 port: 0D0H = 320Q CP/M Configuration (Main Menu) (Default I/O Configuration – Submenu C) CON: = CON: = TTY: CP/M Configuration (Main Menu)
Diablo KSR 1640 terminal	A B 12 320 Y C A TTY Y	(Terminal and Printer Characteristics – Submenu A) TTY: baud rate: TTY: baud rate: 1200 port: TTY: baud rate: 1200 port: 0D0H = 320Q CP/M Configuration (Main Menu) (Default I/O Configuration – Submenu C) CON: = CON: = TTY: CP/M Configuration (Main Menu)

Table 1-7
Terminals with Z89-3 Interface

Your Terminal	Keyboard Entries	Excerpt or Description of Desired Display
Zenith or Heath Z-19, H-19, Z-88, H-88, Z-89, H-89, or Z-90 Terminal	A A 9 350 Y C A CRT Y	(Terminal and Printer Characteristics – Submenu A) CRT: baud rate: CRT: baud rate: 9600 port: CRT: baud rate: 9600 port: 0E8H = 350Q CP/M Configuration (Main Menu) (Default I/O Configuration – Submenu C) CRT: = CON: = CRT: CP/M Configuration (Main Menu)
DECwriter LA-34 or LA-36 terminal	A B 30 330 Y C A TTY Y	(Terminal and Printer Characteristics – Submenu A) TTY: baud rate: TTY: baud rate: 300 port: TTY: baud rate: 300 port: 0D8H = 330Q CP/M Configuration (Main Menu) (Default I/O Configuration – Submenu C) CON: = CON: = TTY: CP/M Configuration (Main Menu)
Diablo KSR 1640 terminal	A B 12 330 Y C A TTY Y	(Terminal and Printer Characteristics – Submenu A) TTY: baud rate: TTY: baud rate: 1200 port: TTY: baud rate: 1200 port: 0D8H = 330Q CP/M Configuration (Main Menu) (Default I/O Configuration – Submenu C) CON: = CON: = TTY: CP/M Configuration (Main Menu)

Table 1-8
Terminals with Z89-11 Interface

6. Refer to Table 1-9 if you have a Z89-3 interface card, and to Table 1-10 if you have a Z89-11 interface card. Using the appropriate table, type the keyboard entries listed for your printer. To the right of each entry is an excerpt or description of part of the display that should appear immediately **after** you type the entry. If the excerpted or described display in the table does not appear, repeat the entry.

Your Printer	Keyboard Entries	Excerpt or Description of Desired Display
Diablo 630, 1640, or 1650 printer	A C 12 340 none none Y C D UL1 Y	(Terminal and Printer Characteristics – Submenu A) LST: baud rate: LST: baud rate: 1200 port: LST: baud rate: 1200 port: 0E0H = 340Q Serial Printer Ready Signal Polarity: LOW Serial Printer Ready Signal: RTS (Pin 4) CP/M Configuration (Main Menu) (Default I/O Configuration – Submenu C) LST: = LST: = UL1: CP/M Configuration (Main Menu)
DECwriter LA-34 or LA-36 printer	A C 30 340 none none Y C D LPT Y	(Terminal and Printer Characteristics – Submenu A) LST: baud rate: LST: baud rate: 300 port: LST: baud rate: 300 port: 0E0H = 340Q Serial Printer Ready Signal Polarity: LOW Serial Printer Ready Signal: RTS (Pin 4) CP/M Configuration (Main Menu) (Default I/O Configuration – Submenu C) LST: = LST: = LPT: CP/M Configuration (Main Menu)
Heath H-14 printer	A C 4 340 none none Y C D LPT Y	(Terminal and Printer Characteristics – Submenu A) LST: baud rate: LST: baud rate: 4800 port: LST: baud rate: 4800 port: 0E0H = 340Q Serial Printer Ready Signal Polarity: LOW Serial Printer Ready Signal: RTS (Pin 4) CP/M Configuration (Main Menu) (Default I/O Configuration – Submenu C) LST: = LST: = LPT: CP/M Configuration (Main Menu)

Table 1-9
Printers with Z89-3 Interface
(continued on next page)

Your Printer	Keyboard Entries	Excerpt or Description of Desired Display
Texas Instruments TI-810 printer	A C 4 340 none none Y C D LPT Y	(Terminal and Printer Characteristics – Submenu A) LST: baud rate: LST: baud rate: 4800 port: LST: baud rate: 4800 port: OE0H = 340Q Serial Printer Ready Signal Polarity: LOW Serial Printer Ready Signal: RTS (Pin 4) CP/M Configuration (Main Menu) (Default I/O Configuration – Submenu C) LST: = LST: = LPT: CP/M Configuration (Main Menu)
Zenith or Heath Z-25 or H-25 printer	A C 4 340 M none Y C D LPT Y	(Terminal and Printer Characteristics – Submenu A) LST: baud rate: LST: baud rate: 4800 port: LST: baud rate: 4800 port: OE0H = 340Q Serial Printer Ready Signal Polarity: HIGH Serial Printer Ready Signal: RTS (Pin 4) CP/M Configuration (Main Menu) (Default I/O Configuration – Submenu C) LST: = LST: = LPT: CP/M Configuration (Main Menu)
Epson MX-80 serial printer	A C 4 340 M N Y C D LPT Y	(Terminal and Printer Characteristics – Submenu A) LST: baud rate: LST: baud rate: 4800 port: LST: baud rate: 4800 port: OE0H = 340Q Serial Printer Ready Signal Polarity: HIGH Serial Printer Ready Singal: DTR (Pin 20) CP/M Configuration (Main Menu) (Default I/O Configuration – Submenu C) LST: = LST: = LPT: CP/M Configuration (Main Menu)

Table 1-9
Printers with Z89-3 Interface
(continued from preceding page)

Your Printer	Keyboard Entries	Excerpt or Description of Desired Display
Diablo 630, 1640, or 1650 printer	A C 12 340 none none Y C D UL1 Y	(Terminal and Printer Characteristics – Submenu A) LST: baud rate: LST: baud rate: 1200 port: LST: baud rate: 1200 port: OE0H = 340Q Serial Printer Ready Signal Polarity: LOW Serial Printer Ready Signal: RTS (Pin 4) CP/M Configuration (Main Menu) (Default I/O Configuration – Submenu C) LST: = LST: = UL1: CP/M Configuration (Main Menu)
DECwriter LA-34 or LA-36 printer	A C 30 340 none none P Y C D LPT Y	(Terminal and Printer Characteristics – Submenu A) LST: baud rate: LST: baud rate: 300 port: LST: baud rate: 300 port: OE0H = 340Q Serial Printer Ready Signal Polarity: LOW Serial Printer Ready Signal: RTS (Pin 4) Z89-11 LPT Selection: SERIAL CP/M Configuration (Main Menu) (Default I/O Configuration – Submenu C) LST: = LST: = LPT: CP/M Configuration (Main Menu)
Heath H-14 printer	A C 4 340 none none P Y C D LPT Y	(Terminal and Printer Characteristics – Submenu A) LST: baud rate: LST: baud rate: 4800 port: LST: baud rate: 4800 port: OE0H = 340Q Serial Printer Ready Signal Polarity: LOW Serial Printer Ready Signal: RTS (Pin 4) Z89-11 LPT Selection: SERIAL CP/M Configuration (Main Menu) (Default I/O Configuration – Submenu C) LST: = LST: = LPT: CP/M Configuration (Main Menu)

Table 1-10
Printers with Z89-3 Interface
(continued on next page)

Your Printer	Keyboard Entries	Excerpt or Description of Desired Display
Texas Instruments TI-810 printer	A C 4 340 none none P Y C D LPT Y	(Terminal and Printer Characteristics – Submenu A) LST: baud rate: LST: baud rate: 4800 port: LST: baud rate: 4800 port: OE0H = 340Q Serial Printer Ready Signal Polarity: LOW Serial Printer Ready Signal: RTS (Pin 4) Z89-11 LPT Selection: SERIAL CP/M Configuration (Main Menu) (Default I/O Configuration – Submenu C) LST: = LST: = LPT: CP/M Configuration (Main Menu)
Zenith or Heath Z-25 or H-25 printer	A C 4 340 M none P Y C D LPT Y	(Terminal and Printer Characteristics – Submenu A) LST: baud rate: LST: baud rate: 4800 port: LST: baud rate: 4800 port: OE0H = 340Q Serial Printer Ready Signal Polarity: HIGH Serial Printer Ready Signal: RTS (Pin 4) Z89-11 LPT Selection: SERIAL CP/M Configuration (Main Menu) (Default I/O Configuration – Submenu C) LST: = LST: = LPT: CP/M Configuration (Main Menu)
Epson MX-80 serial printer	A C 4 340 M N P Y C D LPT Y	(Terminal and Printer Characteristics – Submenu A) LST: baud rate: LST: baud rate: 4800 port: LST: baud rate: 4800 port: OE0H = 340Q Serial Printer Ready Signal Polarity: HIGH Serial Printer Ready Singal: DTR (Pin 20) Z89-11 LPT Selection: SERIAL CP/M Configuration (Main Menu) (Default I/O Configuration – Submenu C) LST: = LST: = LPT: CP/M Configuration (Main Menu)

Table 1-10
Printers with Z89-11 Interface
(continued on next page)

Your Printer	Keyboard Entries	Excerpt or Description of Desired Display
Epson MX-80 parallel printer	A none none Y C D LPT Y	(Terminal and Printer Characteristics – Submenu A) Parallel Printer Ready Signal Polarity: HIGH Z89-11 LPT Selection: PARALLEL CP/M Configuration (Main Menu) (Default I/O Configuration – Submenu C) LST: = LST: = LPT: CP/M Configuration (Main Menu)

Table 1-10
 Printers with Z89-11 Interface
 (continued from preceding page)

7. CONFIGUR should now display the selection menu labelled “CP/M Configuration”. Respond to the selection prompt in this menu by typing **Y**. CP/M will display the “A>” system prompt.

You have just completed your customization procedure. If you correctly followed your entire customization procedure, your System Disk should contain a copy of the CP/M Operating System that controls all components of your hardware environment.

To combine this customized operating system with an application program, proceed to the “Working Disk Procedures”.

NOTE: If you have any hardware devices that are **not** listed in these tables and are still not working with your System Disk, then use the instructions in Volume II: The CP/M Reference Guide to perform the CONFIGUR activity.

If you have devices that are listed in these tables and they still don't function properly with your System Disk, then the devices themselves might have been set with characteristics that this text could not anticipate. Therefore you should refer to your Hardware manual(s) for hardware settings instructions, and to Volume II: The CP/M Reference Guide for CONFIGUR instructions.

Customizing Procedure Two

Two or Three Primary Floppy Drives of the Same Type and No Secondary Drives

This procedure will help you to customize a copy of the CP/M Operating System taken from your Backup Disk (or Backup Disk I), and put this customized system copy on a blank disk. The blank disk must be manufactured the same type as the Backup Disk, Label this blank disk "System Disk". The System Disk must be write enabled during this procedure.

PROCEDURE SYNOPSIS

This procedure requires you to perform the following activities in sequence:

```
bootstrap  
CONFIGUR  
FORMAT  
MOVCPM*  
SYSGEN  
bootstrap  
PIP  
bootstrap  
CONFIGUR
```

To begin Customizing Procedure Two, insert your Backup Disk (or Backup Disk I) in drive A and your System Disk in drive B. Perform bootstrap. The CONFIGUR utility will be invoked automatically. Proceed to the CONFIGUR activity.

* Use either MOVCPM17 or MOVCPM37 or MOVCPM47.

CONFIGUR

This CONFIGUR activity customizes the operating system that you placed in memory when you performed bootstrap so that you can copy data to your backup disk(s). There are two methods for performing this CONFIGUR activity, so use **ONLY** the method specified below for your primary drive group.

If your primary drives are 48 TPI 5.25-inch drives or 8-inch drives, then use Method A for this CONFIGUR activity.

If your primary drives are 96 TPI 5.25-inch drives, then use Method B for this CONFIGUR activity.

Method A

When the CONFIGUR utility is automatically invoked, it will display several messages. When CONFIGUR displays the message:

```
STANDARD SYSTEM (Y OR N)? <Y>:
```

type **Y**. The CONFIGUR activity will end, and CP/M will display the A> system prompt.

Proceed to the FORMAT activity.

Method B

When the CONFIGUR utility is automatically invoked, it will display several messages. When CONFIGUR displays the message:

```
STANDARD SYSTEM (Y OR N)? <Y>:
```

type the sequence of keyboard entries listed in Table 1-11. To the right of each entry is an excerpt or description of the part of the display that should appear immediately **after** you type the entry.

Keyboard Entries	Excerpt or Description of Desired Display
N B A 6 RETURN 96 RETURN B 6 RETURN 96 RETURN Y D A Y Y	CP/M CONFIGURATION (Main Menu) 5.25 INCH SOFT-SECTORED UNIT 0 STEP RATE: 30MS TRACK DENSITY: 48TPI 5.25 INCH SOFT-SECTORED UNIT 1 STEP RATE: 30MS TRACK DENSITY: 48TPI SOFT-SECTOR UNIT 0 STEP RATE ? SOFT-SECTOR UNIT 0 STEP RATE ? 6 SOFT-SECTOR UNIT 0 TRACK DENSITY ? SOFT-SECTOR UNIT 0 TRACK DENSITY ? 96 5.25 INCH SOFT-SECTORED UNIT 0 STEP RATE: 6MS TRACK DENSITY: 96TPI 5.25 INCH SOFT-SECTORED UNIT 1 STEP RATE: 30MS TRACK DENSITY: 48TPI SOFT-SECTOR UNIT 1 STEP RATE ? SOFT-SECTOR UNIT 1 STEP RATE ? 6 SOFT-SECTOR UNIT 1 TRACK DENSITY ? SOFT-SECTOR UNIT 1 TRACK DENSITY ? 96 5.25 INCH SOFT-SECTORED UNIT 0 STEP RATE: 6MS TRACK DENSITY: 96TPI 5.25 INCH SOFT-SECTORED UNIT 1 STEP RATE: 6MS TRACK DENSITY: 96TPI CP/M CONFIGURATION (Main Menu) RUN AUTOMATIC COMMAND LINE ON COLD BOOT: TRUE RUN AUTOMATIC COMMAND LINE ON COLD BOOT: FALSE CP/M CONFIGURATION (Main Menu) A> (CP/M system prompt)

Table 1-11
CONFIGUR Entries for One 96 TPI Drive

When the A> system prompt appears, proceed to the FORMAT activity.

NOTE: If the display excerpted or described in the table does not appear, read the CONFIGUR text in "Volume II: The CP/M Reference Guide".

FORMAT

The FORMAT utility prepares your System Disk for data storage. However, FORMAT works differently depending on the type of disk you are using. Therefore, use the FORMAT method specified below:

If your System Disk is hard-sectored, use Method A to FORMAT and follow the numbered steps preceded by the letter A.

If your System Disk is soft-sectored, use Method B to FORMAT and follow the numbered steps preceded by the letter B.

Method A:

- A1. At the A> System Prompt, type **FORMAT** and press **RETURN**. This entry invokes **FORMAT**, which displays a message in the form:

```
Format Version 2.04
This program is used to initialize a disk.
All information currently on the disk will be destroyed.
Is that what you want? (y/n):
```

- A2. Type **Y**. **FORMAT** will display:

```
Which drive do you wish to use for this operation?
```

- A3. Type **B**. **FORMAT** will display:

```
Put the disk you wish to be formatted in drive B.
Press RETURN to begin, anything else to abort.
```

- A4. Make sure that the System Disk is properly situated in drive B, and press **RETURN**. The light on the disk drive will glow for several seconds. Then **FORMAT** will display:

```
Do you have more disks to format? (y/n):
```

- A5. Type **N**. **CP/M** will display the system prompt:

```
A>
```

Proceed to the **MOVCPM** activity.

Method B:

- B1. After the **CP/M** prompt A>, type **FORMAT** and press **RETURN**. This entry invokes **FORMAT**, which displays a message in the form:

```
Format Version 2.04
This program is used to initialize a disk.
All information currently on the disk will be destroyed.
Is that what you want? (y/n):
```

- B2. Type **Y**. **FORMAT** will display:

```
Which drive do you wish to use for this operation?
```

- B3. Type B. FORMAT will display one of the following two messages:**

Which density? (S=single, D=double):

or

Which density? (S=single, D=double, E=extended double):

- B4. If your System Disk is a single-density disk, type S.**

If your System Disk is a double-density disk, type D.

- B5. After you respond to the density prompt, FORMAT's response will depend upon the kind of disk you are formatting.**

If your System Disk is an 8-inch disk, proceed to step B7.

If your System Disk is a 5.25 inch soft-sectored disk, FORMAT will display:

Number of sides? (1=single, 2=double):

- B6. If your System Disk is a single-sided disk, type 1.**

If your System Disk is a double-sided disk, type 2.

After you respond to the side quantity prompt, FORMAT will display one of the following two messages:

48 TPI drive -- 40 tracks will be formatted

or

96 TPI drive -- 80 tracks will be formatted

(If the type of TPI drive specified here does not match your drives, repeat the previous CONFIGUR activity.)

- B7. FORMAT will also display the following prompt:**

Put the disk you wish to be formatted in drive B.
Press RETURN to begin, anything else to abort.

- B8. Make sure that the System Disk is properly situated in drive B, and press **RETURN**. The light on the disk drive will glow for several seconds. Then FORMAT will display:

Do you have more disks to format? (Y/N):

- B9. Type N. CP/M will display:

A>

Proceed to the MOVCPM activity.

MOVCPM

The MOVCPM utilities enable you to adjust the amount of memory space that the CP/M Operating System will occupy in your microcomputer. Your computer has a memory limit of either 32K, 48K, or 64K. However, the operating system on your Backup Disk is preset to occupy only 32K. ("K" stands for kilobyte, a unit of data storage space.)

MOVCPM loads part of the operating system into a special location in computer memory, and allows this part of the system to expand until it fills the computer's entire memory capacity.

If your computer's memory limit is 32K, then skip the MOVCPM activity and proceed to the instructions for the SYSGEN activity (Method B).

If the memory limit "nn" indicated in the bootstrap message ("nnK HEATH/ZENITH CP/M v.v.vv") is smaller than the your computer's limit, then use one of the MOVCPM utilities to raise the memory limit on your operating system, so that it matches that of your computer.

NOTE: If you don't use MOVCPM to take advantage of all of your computer's available memory space, you will not be able to use your CP/M system with large application programs that require more than 32k of memory space to operate.

1. If you are customizing CP/M Version 2.2.04 with a 5.25-inch hard-sectored System Disk, then enter the following command in response to the system prompt:

A>**MOVCPM17**

If you are customizing CP/M Version 2.2.04 with a 5.25-inch soft-sectored System Disk, then enter the following command in response to the system prompt:

A>MOVCPM37

If you are customizing CP/M Version 2.2.04 with an 8-inch System Disk, then enter the following command in response to the system prompt:

A>MOVCPM47

2. Wait for the MOVCPM utility to display a message in the following form:

```
MOVCPMxx Version 2.2.04
```

```
CONSTRUCTING nnk CP/M vers 2.2  
READY FOR "SYSGEN" OR  
"SAVE 38 CPMnn.COM"
```

Proceed immediately to the SYSGEN activity.

SYSGEN

The SYSGEN utility copies some or all of the CP/M Operating System onto your System Disk. SYSGEN might get this operating system copy from the Backup Disk, or from a special location in computer memory (if a MOVCPM activity put part of the operating system in this special memory location.)

If you just performed a MOVCPM activity, use SYSGEN Method A and follow the numbered steps preceded by the letter A.

If the memory limit indicated in the bootstrap message ("nnK HEATH/ZENITH CP/M v.v.vv") matches the actual memory limit of your micro-computer, then use SYSGEN Method B and follow the numbered steps preceded by the letter B.

Method A

- A1. At the A> prompt, type **SYSGEN** and press **RETURN**. This entry invokes the SYSGEN utility, which displays a message in the form:

```
SYSGEN VERSION 2.0.04
SOURCE DRIVE NAME (OR RETURN TO SKIP): RETURN
```

- A2. Press **RETURN** as shown above. The computer will print:

```
DESTINATION DRIVE NAME (OR RETURN TO REBOOT):
```

- A3. Type **B**. CP/M will respond:

```
DESTINATION ON B, THEN TYPE RETURN
```

- A4. Press **RETURN**. CP/M will print:

```
FUNCTION COMPLETE.
DESTINATION DRIVE NAME (OR RETURN TO REBOOT):
```

- A5. Reset the computer. Do not enter a carriage return at this prompt. Then perform bootstrap with the Backup Disk in drive A: CP/M will display the system prompt:

```
A>
```

Proceed to the PIP activity.

Method B

- B1. At the A> prompt, type **SYSGEN** and press **RETURN**. This entry invokes SYSGEN, which displays a message in the form:

```
SYSGEN VERSION 2.0.04
SOURCE DRIVE NAME (OR RETURN TO SKIP):
```

- B2. Type **A**. SYSGEN will display:

```
SOURCE ON A, THEN TYPE RETURN
```

- B3. Press **RETURN**. SYSGEN will display:

```
FUNCTION COMPLETE
COPY BIOS.SYS (Y/N):
```

B4. Type **Y**. SYSGEN will display:

FUNCTION COMPLETE
DESTINATION DRIVE NAME (OR RETURN TO REBOOT):

B5. Type **B**. SYSGEN will display:

DESTINATION ON B, THEN TYPE RETURN

B6. Press **RETURN**. SYSGEN will display:

FUNCTION COMPLETE.
DESTINATION DRIVE NAME (OR RETURN TO REBOOT):

B7. Reset the computer. Remove the Backup Disk from drive A:, and insert the System Disk in drive A:. Then insert the Backup Disk in drive B:. Perform bootstrap using the System Disk. CP/M will display the system prompt:

A>

Proceed to the CONFIGUR activity.

PIP

This PIP activity will help you to copy the BIOS.SYS file from your Backup Disk to your System Disk.

1. At the A> prompt, type the following command line:

A>**PIP B: = A:BIOS.SYS[R]**

Where **B:** represents the System Disk (the destination of the BIOS.SYS file);

where **A:** represents the Backup Disk (the source of the BIOS.SYS file);

where **BIOS.SYS** is the file component of the CP/M Operating System; and

where **[R]** is a command line parameter that allows you to copy a file that has Read/Only status (such as BIOS.SYS.)

When PIP has finished copying the BIOS.SYS file, CP/M will redisplay the A> system prompt.

2. At the A> system prompt, reset the computer.
3. Insert the System Disk into drive A, and perform bootstrap to test this disk.

Proceed to the CONFIGUR activity.

CONFIGUR

The CONFIGUR utility customizes the operating system on your System Disk to match several characteristics of your hardware environment. This procedure will show you how to use CONFIGUR to customize the system for only essential hardware characteristics. (Use the CONFIGUR instructions in the Volume II: The CP/M Reference Guide if you want more detailed instructions on using CONFIGUR.)

To begin this activity, you should have your System Disk in drive A, and your Backup Disk (or Backup Disk I) in drive B.

1. Perform bootstrap with the System Disk. CP/M will display the "A>" system prompt.
2. Type the command **B:CONFIGUR RETURN** at the system prompt. This entry invokes CONFIGUR, which will present a display that begins with an identification message in the following form:

```
Heath/Zenith Configuration Program
Version 2.2.04
Serial Number: sss-sssss
```

Take note of your version number. CONFIGUR will continue to display messages, ending with the following prompt:

```
STANDARD SYSTEM (Y OR N)? <Y>:
```

3. Type N. CONFIGUR will display a selection menu labelled "CP/M Configuration".

4. Refer to Table 1-12 if you have a Z89-3 interface card, and to Table 1-13 if you have a Z89-11 interface card. Using the appropriate table, type the keyboard entries listed for your terminal. To the right of each entry is an excerpt or description of part of the display that should appear immediately **after** you type the entry. If the excerpted or described display in the table does not appear on your terminal, repeat the entry.

NOTE: Type only the capital letters or numbers featured in bold faced type beneath the heading "Keyboard Entries". Do not change the order of the entries listed. If you type an incorrect entry at a prompt, CONFIGUR will either ignore your mistake, or display it. If a mistake is ignored, simply answer the prompt again. If CONFIGUR displays your mistake, you can usually change it by typing **Z** and repeating a few entries.

Your Terminal	Keyboard Entries	Excerpt or Description of Desired Display
Zenith or Heath Z-19, H-19, Z-88, H-88, Z-89, H-89, or Z-90 terminal	A A 9 350 Y C A CRT Y	(Terminal and Printer Characteristics – Submenu A) CRT: baud rate: CRT: baudrate: 9600 port: CRT: baud rate: 9600 port: 0E8H = 350Q CP/M Configuration (Main Menu) (Default I/O Configuration – Submenu C) CRT: = CON: = CRT: CP/M Configuration (Main Menu)
DECwriter LA-34 or LA-36 terminal	A B 30 320 Y C A TTY Y	(Terminal and Printer Characteristics – Submenu A) TTY: baud rate: TTY: baud rate: 300 port: TTY: baud rate: 300 port: 0D0H = 320Q CP/M Configuration (Main Menu) (Default I/O Configuration – Submenu C) CON: = CON: = TTY: CP/M Configuration (Main Menu)
Diablo KSR 1640 terminal	A B 12 320 Y C A TTY Y	(Terminal and Printer Characteristics – Submenu A) TTY: baud rate: TTY: baud rate: 1200 port: TTY: baud rate: 1200 port: 0D0H = 320Q CP/M Configuration (Main Menu) (Default I/O Configuration – Submenu C) CON: = CON: = TTY: CP/M Configuration (Main Menu)

Table 1-12
Terminals with Z89-3 Interface

Your Terminal	Keyboard Entries	Excerpt or Description of Desired Display
Zenith or Heath Z-19, H-19, Z-88, H-88, Z-89, H-89, or Z-90 terminal	A A 9 350 Y C A CRT Y	(Terminal and Printer Characteristics – Submenu A) CRT: baud rate: CRT: baudrate: 9600 port: CRT: baud rate: 9600 port: 0E8H = 350Q CP/M Configuration (Main Menu) (Default I/O Configuration – Submenu C) CRT: = CON: = CRT: CP/M Configuration (Main Menu)
DECwriter LA-34 or LA-36 terminal	A B 30 330 Y C A TTY Y	(Terminal and Printer Characteristics – Submenu A) TTY: baud rate: TTY: baud rate: 300 port: TTY: baud rate: 300 port: 0D8H = 330Q CP/M Configuration (Main Menu) (Default I/O Configuration – Submenu C) CON: = CON: = TTY: CP/M Configuration (Main Menu)
Diablo KSR 1640 terminal	A B 12 330 Y C A TTY Y	(Terminal and Printer Characteristics – Submenu A) TTY: baud rate: TTY: baud rate: 1200 port: TTY: baud rate: 1200 port: 0D8H = 330Q CP/M Configuration (Main Menu) (Default I/O Configuration – Submenu C) CON: = CON: = TTY: CP/M Configuration (Main Menu)

Table 1-13
Terminals with Z89-11 Interface

- Refer to Table 1-14 if you have a Z89-3 interface card, and to Table 1-15 if you have a Z89-11 interface card. Using the appropriate table, type the keyboard entries listed for your printer. To the right of each entry is an excerpt or description of part of the display that should appear immediately **after** you type the entry. If the excerpted or described display in the table does not appear, repeat the entry.

Your Printer	Keyboard Entries	Excerpt or Description of Desired Display
Diablo 630, 1640, or 1650 printer	A C 12 340 none none Y C D UL1 Y	(Terminal and Printer Characteristics – Submenu A) LST: baud rate: LST: baud rate: 1200 port: LST: baud rate: 1200 port: OE0H = 340Q Serial Printer Ready Signal Polarity: LOW Serial Printer Ready Signal: RTS (Pin 4) CP/M Configuration (Main Menu) (Default I/O Configuration – Submenu C) LST: = LST: = UL1: CP/M Configuration (Main Menu)
DECwriter LA-34 or LA-36 printer	A C 30 340 none none Y C D LPT Y	(Terminal and Printer Characteristics – Submenu A) LST: baud rate: LST: baud rate: 300 port: LST: baud rate: 300 port: OE0H = 340Q Serial Printer Ready Signal Polarity: LOW Serial Printer Ready Signal: RTS (Pin 4) CP/M Configuration (Main Menu) (Default I/O Configuration – Submenu C) LST: = LST: = LPT: CP/M Configuration (Main Menu)
Heath H-14 printer	A C 4 340 none none Y C D LPT Y	(Terminal and Printer Characteristics – Submenu A) LST: baud rate: LST: baud rate: 4800 port: LST: baud rate: 4800 port: OE0H = 340Q Serial Printer Ready Signal Polarity: LOW Serial Printer Ready Signal: RTS (Pin 4) CP/M Configuration (Main Menu) (Default I/O Configuration – Submenu C) LST: = LST: = LPT: CP/M Configuration (Main Menu)

Table 1-14
Printers with Z89-3 Interface
(continued on next page)

Your Printer	Keyboard Entries	Excerpt or Description of Desired Display
Texas Instruments TI-810 printer	A C 4 340 none none Y C D LPT Y	(Terminal and Printer Characteristics – Submenu A) LST: baud rate: LST: baud rate: 4800 port: LST: baud rate: 4800 port: OE0H = 340Q Serial Printer Ready Signal Polarity: LOW Serial Printer Ready Signal: RTS (Pin 4) CP/M Configuration (Main Menu) (Default I/O Configuration – Submenu C) LST: = LST: = LPT: CP/M Configuration (Main Menu)
Zenith or Heath Z-25 or H-25 printer	A C 4 340 M none Y C D LPT Y	(Terminal and Printer Characteristics – Submenu A) LST: baud rate: LST: baud rate: 4800 port: LST: baud rate: 4800 port: OE0H = 340Q Serial Printer Ready Signal Polarity: HIGH Serial Printer Ready Signal: RTS (Pin 4) CP/M Configuration (Main Menu) (Default I/O Configuration – Submenu C) LST: = LST: = LPT: CP/M Configuration (Main Menu)
Epson MX-80 serial printer	A C 4 340 M N Y C D LPT Y	(Terminal and Printer Characteristics – Submenu A) LST: baud rate: LST: baud rate: 4800 port: LST: baud rate: 4800 port: OE0H = 340Q Serial Printer Ready Signal Polarity: HIGH Serial Printer Ready Singal: DTR (Pin 20) CP/M Configuration (Main Menu) (Default I/O Configuration – Submenu C) LST: = LST: = LPT: CP/M Configuration (Main Menu)

Table 1-14
Printers with Z89-3 Interface
(continued from preceding page)

Your Printer	Keyboard Entries	Excerpt or Description of Desired Display
Diablo 630, 1640, or 1650 printer	A C 12 340 none none Y C D UL1 Y	(Terminal and Printer Characteristics – Submenu A) LST: baud rate: LST: baud rate: 1200 port: LST: baud rate: 1200 port: 0EOH = 340Q Serial Printer Ready Signal Polarity: LOW Serial Printer Ready Signal: RTS (Pin 4) CP/M Configuration (Main Menu) (Default I/O Configuration – Submenu C) LST: = LST: = UL1: CP/M Configuration (Main Menu)
DECwriter LA-34 or LA-36 printer	A C 30 340 none none P Y C D LPT Y	(Terminal and Printer Characteristics – Submenu A) LST: baud rate: LST: baud rate: 300 port: LST: baud rate: 300 port: 0EOH = 340Q Serial Printer Ready Signal Polarity: LOW Serial Printer Ready Signal: RTS (Pin 4) Z89-11 LPT Selection: SERIAL CP/M Configuration (Main Menu) (Default I/O Configuration – Submenu C) LST: = LST: = LPT: CP/M Configuration (Main Menu)
Heath H-14 printer	A C 4 340 none none P Y C D LPT Y	(Terminal and Printer Characteristics – Submenu A) LST: baud rate: LST: baud rate: 4800 port: LST: baud rate: 4800 port: 0EOH = 340Q Serial Printer Ready Signal Polarity: LOW Serial Printer Ready Signal: RTS (Pin 4) Z89-11 LPT Selection: SERIAL CP/M Configuration (Main Menu) (Default I/O Configuration – Submenu C) LST: = LST: = LPT: CP/M Configuration (Main Menu)

Table 1-15
Printers with Z89-11 Interface
(continued on next page)

Your Printer	Keyboard Entries	Excerpt or Description of Desired Display
Texas Instruments TI-810 printer	A C 4 340 none none P Y C D LPT Y	(Terminal and Printer Characteristics – Submenu A) LST: baud rate: LST: baud rate: 4800 port: LST: baud rate: 4800 port: OE0H = 340Q Serial Printer Ready Signal Polarity: LOW Serial Printer Ready Signal: RTS (Pin 4) Z89-11 LPT Selection: SERIAL CP/M Configuration (Main Menu) (Default I/O Configuration – Submenu C) LST: = LST: = LPT: CP/M Configuration (Main Menu)
Zenith or Heath Z-25 or H-25 printer	A C 4 340 M none P Y C D LPT Y	(Terminal and Printer Characteristics – Submenu A) LST: baud rate: LST: baud rate: 4800 port: LST: baud rate: 4800 port: OE0H = 340Q Serial Printer Ready Signal Polarity: HIGH Serial Printer Ready Signal: RTS (Pin 4) Z89-11 LPT Selection: SERIAL CP/M Configuration (Main Menu) (Default I/O Configuration – Submenu C) LST: = LST: = LPT: CP/M Configuration (Main Menu)
Epson MX-80 serial printer	A C 4 340 M N P Y C D LPT Y	(Terminal and Printer Characteristics – Submenu A) LST: baud rate: LST: baud rate: 4800 port: LST: baud rate: 4800 port: OE0H = 340Q Serial Printer Ready Signal Polarity: HIGH Serial Printer Ready Singal: DTR (Pin 20) Z89-11 LPT Selection: SERIAL CP/M Configuration (Main Menu) (Default I/O Configuration – Submenu C) LST: = LST: = LPT: CP/M Configuration (Main Menu)

Table 1-15
Printers with Z89-11 Interface
(continued on next page)

Your Printer	Keyboard Entries	Excerpt or Description of Desired Display
Epson MX-80 parallel printer	A none none Y C D LPT Y	(Terminal and Printer Characteristics – Submenu A) Parallel Printer Ready Signal Polarity: HIGH Z89-11 LPT Selection: PARALLEL CP/M Configuration (Main Menu) (Default I/O Configuration – Submenu C) LST: = LST: = LPT: CP/M Configuration (Main Menu)

Table 1-15

Printers with Z89-11 Interface
 (continued from preceding page)

6. CONFIGUR should now display the selection menu labelled "CP/M Configuration". Respond to the selection prompt in this menu by typing **Y**. CP/M will display the "A>" system prompt.

You have just completed your customization procedure. If you correctly followed your entire customization procedure, your System Disk should contain a copy of the CP/M Operating System that controls all components of your hardware environment.

To combine this customized operating system with an application program, proceed to the "Working Disk Procedures".

NOTE: If you have any hardware devices that are **not** listed in these tables and are still not working with your System Disk, then use the instructions in Volume II: The CP/M Reference Guide to perform the CONFIGUR activity.

If you have devices that are listed in these tables and they still don't function properly with your System Disk, then the devices themselves might have been set with characteristics that this text could not anticipate. Therefore you should refer to your hardware manual(s) for hardware settings instructions, and to Volume II: The CP/M Reference Guide for CONFIGUR instructions.

Customizing Procedure Three

An H/Z67 (Winchester Disk) Drive and No Secondary Drives

or

One 96 TPI, 5.25-Inch and One or Two 48 TPI, 5.25-Inch Primary Drives and No Secondary Drives

This procedure will help you to customize a copy of the CP/M Operating System that resides on your Backup Partition or Disk. If you have a Backup Partition, this procedure will refer to it as a "System Partition". If you have a Backup Disk, this procedure will refer to it as a "System Disk".

PROCEDURE SYNOPSIS

This procedure requires you to perform the following activities in sequence:

```
bootstrap  
CONFIGUR  
MOVCPM*  
SYSGEN  
bootup  
CONFIGUR
```

If you have a System Partition, begin Customizing Procedure Three, by booting up with the System Partition. When the CONFIGUR utility is automatically invoked, wait for the "Standard system" prompt and type Y. Then proceed to the MOVCPM activity (MOVCPM67).

If you have a System Disk, begin Customizing Procedure Three, by inserting the System Disk in the 96 TPI drive and booting up with the System Disk. When the CONFIGUR utility is automatically invoked, wait for the "Standard system" prompt and type N. Then proceed to the CONFIGUR activity.

* Use either MOVCPM67 or MOVCPM37.

CONFIGUR

This CONFIGUR activity enables you to record software on your 96 TPI System Disk.

1. When the CONFIGUR activity is automatically invoked, it will display several messages. Wait for CONFIGUR to display the following message:

```
STANDARD SYSTEM (Y OR N)? >Y<:
```

2. Type **N** at the "STANDARD SYSTEM" prompt. CONFIGUR will display the "CP/M CONFIGURATION" menu.
3. Type **B** at the "SELECTION" prompt beneath the "CP/M CONFIGURATION" menu. CONFIGUR will display the disk parameters menu (submenu B), showing the status of your 5.25-inch drive units.
4. Select the "SOFT SECTORED UNIT" that corresponds to your 96 TPI primary drive. CONFIGUR will prompt you to enter a "STEP RATE".
5. Type **6** for the step rate of your 96 TPI primary drive. (This entry is necessary to change the 30 ms default step rate.) CONFIGUR will prompt you to enter a "TRACK DENSITY".
6. Type **96** for the track density of your 96 TPI primary drive. (This entry is necessary to change the 48 TPI default track density.) CONFIGUR will display the changed status of your 96 TPI drive.
7. Type **Y** at the "SELECTION" prompt beneath the drive disk parameters menu (submenu B). CONFIGUR will redisplay the "CP/M CONFIGURATION" menu.
8. Type **Y** at the "SELECTION" prompt beneath the "CP/M CONFIGURATION" menu. CP/M will display the system prompt.

Proceed to the MOVCPM activity.

MOVCPM

The MOVCPM utilities enable you to adjust the amount of memory space that the CP/M Operating System will occupy in your microcomputer. Your computer has a memory limit of either 32K, 48K, or 64K. However, the operating system on your System Partition is preset to occupy only 32K. ("K" stands for kilobyte, a unit of data storage space.)

MOVCPM67 makes a copy of the operation system from the System Partition, puts this copy at a special location in computer memory, and allows it to expand until it fills the computer's entire memory area.

When you perform bootstrap, CP/M displays its own memory limit. When the CONFIGUR utility is invoked, it displays your computer's memory limit. Compare these two limits.

If the memory limit of CP/M and your computer are the same, then skip this MOVCPM activity, and proceed to the next CONFIGUR activity.

If the memory limit of CP/M and your computer are different, then perform this MOVCPM activity.

1. If you have a System Partition, type **MOVCPM67 RETURN**.

If you have a System Disk, type **MOVCPM37 RETURN**.

2. Wait for the MOVCPM utility to display a message in the following form:

```
MOVCPMxx Version 2.2.04
```

```
CONSTRUCTING nnk CP/M vers 2.2  
READY FOR "SYSGEN" OR  
"SAVE 38 CPMnn.COM"
```

Proceed immediately to the SYSGEN activity.

SYSGEN

The SYSGEN utility puts a modified copy of the CP/M Operation System on the System Partition or System Disk. SYSGEN from a special location in computer memory. (A MOVCPM activity put the operating system in this special memory location.)

1. At the A> prompt, type **SYSGEN** and press **RETURN**. This entry invokes the SYSGEN utility, which displays a message in the form:

```
SYSGEN VERSION 2.0.04  
SOURCE DRIVE NAME (OR RETURN TO SKIP):
```

2. Press **RETURN** SYSGEN will display:

```
DESTINATION DRIVE NAME (OR RETURN TO REBOOT):
```

3. Type **A**. SYSGEN will display:

```
DESTINATION ON A, THEN TYPE RETURN
```

4. Press **RETURN**. SYSGEN will display:

```
FUNCTION COMPLETE.  
DESTINATION DRIVE NAME (OR RETURN TO REBOOT):
```

5. Reset the computer by holding down the **SHIFT** key and pressing the **RESET** key. Do **not** enter a carriage return at this prompt.
6. Boot up with the System Partition or with the System Disk in the 96 TPI drive.

Proceed to the CONFIGUR activity.

CONFIGUR

The CONFIGUR utility customizes the operating system on your System Partition or System Disk to match several characteristics of your hardware environment. This procedure will show you how to use CONFIGUR to customize the system for essential hardware characteristics. (Use the CONFIGUR instructions in the Volume II: The CP/M Reference Guide if you want more detailed instructions on using CONFIGUR.)

1. Type **CONFIGUR RETURN** at the system prompt. This entry invokes CONFIGUR, which will present a display that begins with an identification message in the following form:

```
Heath/Zenith Configuration Program
Version 2.2.04
Serial Number: sss-sssss
```

Note your version number. CONFIGUR will continue to display messages, ending with the following prompt:

```
STANDARD SYSTEM (Y OR N)? <Y>:
```

2. Type **N**. CONFIGUR will display a selection menu labelled "CP/M Configuration".
3. Refer to Table 1-16 if you have a Z89-3 interface card, and to Table 1-17 if you have a Z89-11 interface card. Using the appropriate table, type the keyboard entries listed for your terminal. To the right of each entry is an excerpt or description of part of the display that should appear immediately **after** you type the entry. If the excerpted or described display in the table does not appear on your terminal, repeat the entry.

NOTE: Type only the capital letters or numbers featured in bold faced type beneath the heading "Keyboard Entries". Do not change the order of the entries listed. If you type an incorrect entry at a prompt, CONFIGUR will either ignore your mistake, or display it. If a mistake is ignored, simply answer the prompt again. If CONFIGUR displays your mistake, you can usually change it by typing **Z** and repeating a few entries.

Your Terminal	Keyboard Entries	Excerpt or Description of Desired Display
Zenith or Heath Z-19, H-19, Z-88, H-88, Z-89, H-89, or Z-90 terminal	A A 9 350 Y C A CRT Y	(Terminal and Printer Characteristics – Submenu A) CRT: baud rate: CRT: baudrate: 9600 port: CRT: baud rate: 9600 port: 0E8H = 350Q CP/M Configuration (Main Menu) (Default I/O Configuration – Submenu C) CRT: = CON: = CRT: CP/M Configuration (Main Menu)
DECwriter LA-34 or LA-36 terminal	A B 30 320 Y C A TTY Y	(Terminal and Printer Characteristics – Submenu A) TTY: baud rate: TTY: baud rate: 300 port: TTY: baud rate: 300 port: 0D0H = 320Q CP/M Configuration (Main Menu) (Default I/O Configuration – Submenu C) CON: = CON: = TTY: CP/M Configuration (Main Menu)
Diablo KSR 1640 terminal	A B 12 320 Y C A TTY Y	(Terminal and Printer Characteristics – Submenu A) TTY: baud rate: TTY: baud rate: 1200 port: TTY: baud rate: 1200 port: 0D0H = 320Q CP/M Configuration (Main Menu) (Default I/O Configuration – Submenu C) CON: = CON: = TTY: CP/M Configuration (Main Menu)

Table 1-16
Terminals with Z89-3 Interface

Your Terminal	Keyboard Entries	Excerpt or Description of Desired Display
Zenith or Heath Z-19, H-19, Z-88, H-88, Z-89, H-89, or Z-90 terminal	A A 9 350 Y C A CRT Y	(Terminal and Printer Characteristics – Submenu A) CRT: baud rate: CRT: baudrate: 9600 port: CRT: baud rate: 9600 port: 0E8H = 350Q CP/M Configuration (Main Menu) (Default I/O Configuration – Submenu C) CRT: = CON: = CRT: CP/M Configuration (Main Menu)
DECwriter LA-34 or LA-36 terminal	A B 30 330 Y C A TTY Y	(Terminal and Printer Characteristics – Submenu A) TTY: baud rate: TTY: baud rate: 300 port: TTY: baud rate: 300 port: 0D8H = 330Q CP/M Configuration (Main Menu) (Default I/O Configuration – Submenu C) CON: = CON: = TTY: CP/M Configuration (Main Menu)
Diablo KSR 1640 terminal	A B 12 330 Y C A TTY Y	(Terminal and Printer Characteristics – Submenu A) TTY: baud rate: TTY: baud rate: 1200 port: TTY: baud rate: 1200 port: 0D8H = 330Q CP/M Configuration (Main Menu) (Default I/O Configuration – Submenu C) CON: = CON: = TTY: CP/M Configuration (Main Menu)

Table 1-17

Terminals with Z89-11 Interface

- Refer to Table 1-18 if you have a Z89-3 interface card, and to Table 1-19 if you have a Z89-11 interface card. Using the appropriate table, type the keyboard entries listed for your printer. To the right of each entry is an excerpt or description of part of the display that should appear immediately **after** you type the entry. If the excerpted or described display in the table does not appear, repeat the entry.

Your Printer	Keyboard Entries	Excerpt or Description of Desired Display
Diablo 630, 1640, or 1650 printer	A C 12 340 none none Y C D UL1 Y	(Terminal and Printer Characteristics – Submenu A) LST: baud rate: LST: baud rate: 1200 port: LST: baud rate: 1200 port: OE0H = 340Q Serial Printer Ready Signal Polarity: LOW Serial Printer Ready Signal: RTS (Pin 4) CP/M Configuration (Main Menu) (Default I/O Configuration – Submenu C) LST: = LST: = UL1: CP/M Configuration (Main Menu)
DECwriter LA-34 or LA-36 printer	A C 30 340 none none Y C D LPT Y	(Terminal and Printer Characteristics – Submenu A) LST: baud rate: LST: baud rate: 300 port: LST: baud rate: 300 port: OE0H = 340Q Serial Printer Ready Signal Polarity: LOW Serial Printer Ready Signal: RTS (Pin 4) CP/M Configuration (Main Menu) (Default I/O Configuration – Submenu C) LST: = LST: = LPT: CP/M Configuration (Main Menu)
Heath H-14 printer	A C 4 340 none none Y C D LPT Y	(Terminal and Printer Characteristics – Submenu A) LST: baud rate: LST: baud rate: 4800 port: LST: baud rate: 4800 port: OE0H = 340Q Serial Printer Ready Signal Polarity: LOW Serial Printer Ready Signal: RTS (Pin 4) CP/M Configuration (Main Menu) (Default I/O Configuration – Submenu C) LST: = LST: = LPT: CP/M Configuration (Main Menu)

Table 1-18
Printers with Z89-3 Interface
(continued on next page)

Your Printer	Keyboard Entries	Excerpt or Description of Desired Display
Texas Instruments TI-810 printer	A C 4 340 none none Y C D LPT Y	(Terminal and Printer Characteristics – Submenu A) LST: baud rate: LST: baud rate: 4800 port: LST: baud rate: 4800 port: OEOH = 340Q Serial Printer Ready Signal Polarity: LOW Serial Printer Ready Signal: RTS (Pin 4) CP/M Configuration (Main Menu) (Default I/O Configuration – Submenu C) LST: = LST: = LPT: CP/M Configuration (Main Menu)
Zenith or Heath Z-25 or H-25 printer	A C 4 340 M none Y C D LPT Y	(Terminal and Printer Characteristics – Submenu A) LST: baud rate: LST: baud rate: 4800 port: LST: baud rate: 4800 port: OEOH = 340Q Serial Printer Ready Signal Polarity: HIGH Serial Printer Ready Signal: RTS (Pin 4) CP/M Configuration (Main Menu) (Default I/O Configuration – Submenu C) LST: = LST: = LPT: CP/M Configuration (Main Menu)
Epson MX-80 serial printer	A C 4 340 M N Y C D LPT Y	(Terminal and Printer Characteristics – Submenu A) LST: baud rate: LST: baud rate: 4800 port: LST: baud rate: 4800 port: OEOH = 340Q Serial Printer Ready Signal Polarity: HIGH Serial Printer Ready Singal: DTR (Pin 20) CP/M Configuration (Main Menu) (Default I/O Configuration – Submenu C) LST: = LST: = LPT: CP/M Configuration (Main Menu)

Table 1-18
 Printers with Z89-3 Interface
 (continued from preceding page)

Your Printer	Keyboard Entries	Excerpt or Description of Desired Display
Diablo 630, 1640, or 1650 printer	A C 12 340 none none Y C D UL1 Y	(Terminal and Printer Characteristics – Submenu A) LST: baud rate: LST: baud rate: 1200 port: LST: baud rate: 1200 port: OE0H = 340Q Serial Printer Ready Signal Polarity: LOW Serial Printer Ready Signal: RTS (Pin 4) CP/M Configuration (Main Menu) (Default I/O Configuration – Submenu C) LST: = LST: = UL1: CP/M Configuration (Main Menu)
DECwriter LA-34 or LA-36 printer	A C 30 340 none none P Y C D LPT Y	(Terminal and Printer Characteristics – Submenu A) LST: baud rate: LST: baud rate: 300 port: LST: baud rate: 300 port: OE0H = 340Q Serial Printer Ready Signal Polarity: LOW Serial Printer Ready Signal: RTS (Pin 4) Z89-11 LPT Selection: SERIAL CP/M Configuration (Main Menu) (Default I/O Configuration – Submenu C) LST: = LST: = LPT: CP/M Configuration (Main Menu)
Heath H-14 printer	A C 4 340 none none P Y C D LPT Y	(Terminal and Printer Characteristics – Submenu A) LST: baud rate: LST: baud rate: 4800 port: LST: baud rate: 4800 port: OE0H = 340Q Serial Printer Ready Signal Polarity: LOW Serial Printer Ready Signal: RTS (Pin 4) Z89-11 LPT Selection: SERIAL CP/M Configuration (Main Menu) (Default I/O Configuration – Submenu C) LST: = LST: = LPT: CP/M Configuration (Main Menu)

Table 1-19
Printers with Z89-11 Interface
(continued on next page)

Your Printer	Keyboard Entries	Excerpt or Description of Desired Display
Texas Instruments TI-810 printer	A C 4 340 none none P Y C D LPT Y	(Terminal and Printer Characteristics – Submenu A) LST: baud rate: LST: baud rate: 4800 port: LST: baud rate: 4800 port: 0E0H = 340Q Serial Printer Ready Signal Polarity: LOW Serial Printer Ready Signal: RTS (Pin 4) Z89-11 LPT Selection: SERIAL CP/M Configuration (Main Menu) (Default I/O Configuration – Submenu C) LST: = LST: = LPT: CP/M Configuration (Main Menu)
Zenith or Heath Z-25 or H-25 printer	A C 4 340 M none P Y C D LPT Y	(Terminal and Printer Characteristics – Submenu A) LST: baud rate: LST: baud rate: 4800 port: LST: baud rate: 4800 port: 0E0H = 340Q Serial Printer Ready Signal Polarity: HIGH Serial Printer Ready Signal: RTS (Pin 4) Z89-11 LPT Selection: SERIAL CP/M Configuration (Main Menu) (Default I/O Configuration – Submenu C) LST: = LST: = LPT: CP/M Configuration (Main Menu)
Epson MX-80 serial printer	A C 4 340 M N P Y C D LPT Y	(Terminal and Printer Characteristics – Submenu A) LST: baud rate: LST: baud rate: 4800 port: LST: baud rate: 4800 port: 0E0H = 340Q Serial Printer Ready Signal Polarity: HIGH Serial Printer Ready Singal: DTR (Pin 20) Z89-11 LPT Selection: SERIAL CP/M Configuration (Main Menu) (Default I/O Configuration – Submenu C) LST: = LST: = LPT: CP/M Configuration (Main Menu)

Table 1-19
Printers with Z89-11 Interface
(continued on next page)

Your Printer	Keyboard Entries	Excerpt or Description of Desired Display
Epson MX-80 parallel printer	A none none Y C D LPT Y	(Terminal and Printer Characteristics – Submenu A) Parallel Printer Ready Signal Polarity: HIGH Z89-11 LPT Selection: PARALLEL CP/M Configuration (Main Menu) (Default I/O Configuration – Submenu C) LST: = LST: = LPT: CP/M Configuration (Main Menu)

Table 1-19

Printers with Z89-11 Interface
 (continued from preceding page)

5. CONFIGUR should now display the selection menu labelled “CP/M Configuration”.

If you have a System Partition (instead of a System Disk), then respond to the selection prompt beneath the “CP/M Configuration” menu by typing **Y**. CP/M will display the “A>” system prompt. You have just completed your customizing procedure.

If you have a System Disk (instead of a System Partition), then respond to the selection prompt beneath the “CP/M Configuration” menu by typing **B**. CONFIGUR will display the disk parameters menu (submenu B), showing the status of your 5.25-inch drive units. Proceed to Step 6.

6. Select the “Soft-Sector Unit” that corresponds to your 96 TPI primary drive. CONFIGUR will prompt you to enter a “Step Rate”.
7. Type **6** for the step rate of your 96 TPI primary drive. (This entry is necessary to change the 30 ms default step rate.) CONFIGUR will prompt you to enter a “Track Density”.
8. Type **96** for the track density of your 96 TPI primary drive. (This entry is necessary to change the 48 TPI default track density.) CONFIGUR will display the changed status of your 96 TPI drive.

9. Type **Y** at the “Selection” prompt beneath the drive disk parameters menu (submenu B). CONFIGUR will redisplay the “CP/M Configuration” menu.
10. Type **Y** at the “Selection” prompt beneath the “CP/M Configuration” menu. CP/M will display the system prompt.

You have just completed your customizing procedure. If you correctly followed your entire customizing procedure, your System Partition or System Disk should contain a copy of the CP/M Operating System that controls all components of your hardware environment.

To combine this customized operating system with an application program, proceed to the text titled “Working Disk Procedures”.

NOTE: If you have any hardware devices that are **not** listed in these tables, then carefully read the instructions in Volume II: The CP/M Reference Guide to perform the CONFIGUR activity.

If you have devices that still don't function properly with your System Partition or System Disk, then the devices themselves might have been set with characteristics that this text could not anticipate. Therefore you should refer to your hardware manual(s) for hardware settings instructions, and to Volume II: The CP/M Reference Guide for CONFIGUR instructions.

Customizing Procedure Four

One Primary 5.25-Inch Floppy Disk Drive Slot, and One or More Secondary Disk Drives

This procedure will help you to customize a copy of the CP/M Operating System taken from the Backup Disk (or Backup Disk I), and put this customized system copy on a blank disk. The blank disk must contain the same type of media as the Backup Disk. Label the blank disk "System Disk".

The disks you use during this procedure must **not** have tabs covering their write-protect notches.

PROCEDURE SYNOPSIS

This procedure requires you to perform the following activities in sequence:

```
bootup
CONFIGUR
FORMAT
MAKEBIOS
MOVCPM*
SYSGEN
bootup
PIP
CONFIGUR
ERA
```

To begin Customizing Procedure Four, insert the Backup Disk (or Backup Disk I) into the primary disk drive. Boot up to the primary disk drive. The CONFIGUR utility will be invoked automatically. Proceed to the CONFIGUR activity.

* Use MOVCPM17 or MOVCPM37.

CONFIGUR

This CONFIGUR activity customizes the operating system that you placed in memory when you performed bootstrap so that you can copy data to your backup disk(s). There are two methods for performing this CONFIGUR activity, so use ONLY the method specified below for your primary drive group.

If your primary drive (the one used for bootstrap) is a 48 TPI drive, then use Method A for this CONFIGUR activity.

If your primary drive (the one used for bootstrap) is a 96 TPI drive, then use Method B for this CONFIGUR activity.

Method A

When the CONFIGUR utility is automatically invoked, it will display several messages. When CONFIGUR displays the message:

```
STANDARD SYSTEM (Y OR N)? <Y>:
```

type **Y**. The CONFIGUR activity will end, and CP/M will display the A> system prompt.

Proceed to the FORMAT activity.

Method B

When the CONFIGUR utility is automatically invoked, it will display several messages. When CONFIGUR displays the message:

```
STANDARD SYSTEM (Y OR N)? <Y>:
```

type the sequence of keyboard entries listed in Table 1-20. To the right of each entry is an excerpt or description of the part of the display that should appear immediately **after** your entry.

Entries	Keyboard Excerpt or Description of Desired Display
N	CP/M CONFIGURATION (Main Menu)
B	5.25 INCH SOFT-SECTORED UNIT 0 STEP RATE: 30MS TRACK DENSITY: 48TPI
A	SOFT-SECTOR UNIT 0 STEP RATE ?
6	SOFT-SECTOR UNIT 0 STEP RATE ? 6
RETURN	SOFT-SECTOR UNIT 0 TRACK DENSITY ?
96	SOFT-SECTOR UNIT 0 TRACK DENSITY ? 96
RETURN	5.25 INCH SOFT-SECTORED UNIT 0 STEP RATE: 6MS TRACK DENSITY: 96TPI
Y	CP/M CONFIGURATION (Main Menu)
Y	A> (CP/M system prompt)

Table 1-20
CONFIGUR Entries for One 96 TPI Drive

When the A> system prompt appears, proceed to the FORMAT activity.

NOTE: If the display excerpted or described in the table does not appear, read the CONFIGUR text in "Volume II: The CP/M Reference Guide".

FORMAT

The FORMAT utility helps you to prepare the System Disk for data storage. The method you use to operate FORMAT depends on the type of disk you are preparing. Use only one of the two FORMAT methods specified below:

If your System Disk is hard-sectored, then use Method A to FORMAT and follow the numbered steps preceded by the letter A.

If your System Disk is soft-sectored (either 48 TPI or 96 TPI), then use Method B to FORMAT and follow the numbered steps preceded by the letter B.

Method A:

- A1. At the A> system prompt, type **FORMAT** and press **RETURN**. This entry invokes FORMAT, which displays a message in the following form:

```
Format Version 2.04
This program is used to initialize a disk.
All information currently on the disk will be destroyed.
Is that what you want? (y/n):
```

- A2. Type **Y**. FORMAT will display:

```
Which drive do you wish to use for this operation?
```

- A3. Type **A**. FORMAT will display:

```
Put the disk you wish to be formatted in drive A.
Press RETURN to begin, anything else to abort.
```

- A4. Remove Backup Disk I, and insert the System Disk. Then close the drive and press **RETURN**.

- A5. The light on the disk drive will glow for several seconds. Then FORMAT will display:

```
Do you have more disks to format? (y/n):
```

- A6. Type **N** and FORMAT will display:

```
Place a bootable disk in drive A and press any character:
```

- A7. Remove the System Disk and insert Backup Disk I in the drive. Then type any character. CP/M will display:

```
A>
```

Leave Backup Disk I in the drive and proceed to the MAKEBIOS activity.

Method B:

- B1. At the A> System Prompt, type **FORMAT** and press **RETURN**. This entry invokes FORMAT, which displays the following:

```
Format Version 2.04
This program is used to initialize a disk.
All information currently on the disk will be destroyed.
Is that what you want? (y/n):
```

- B2. Type **Y**. FORMAT will display:

```
Which drive do you wish to use for this operation?
```

- B3. Type **A**. FORMAT will display:

```
Which density? (S=single, D=double):
```

- B4. If your System Disk is a single-density disk, type **S**.

If your System Disk is a double-density disk, type **D**.

After you respond to the density prompt, FORMAT will display:

```
Number of sides? (1=single, 2=double):
```

- B5. If your System Disk is a single-sided disk, type **1**.

If your System Disk is a double-sided disk, type **2**.

After you respond to the side quantity prompt, FORMAT will display one of the following two messages:

```
48 TPI drive -- 40 tracks will be formatted
```

or

```
96 TPI drive -- 80 tracks will be formatted
```

(If the type of TPI drive specified here does not match your drives, repeat the previous CONFIGUR activity.) FORMAT will also display the following prompt:

```
Put the disk you wish to be formatted in drive A.
Press RETURN to begin, anything else to abort.
```

B6. Immediately remove the Backup Disk (or Backup Disk I), insert the System Disk, and close the disk drive. Then press **RETURN**.

B7. The light on the disk drive will glow for several seconds. Then FORMAT will display:

Do you have more disks to format? (y/n):

B8. Type N, and FORMAT will display:

Place a bootable disk in drive A and press any character:

B9. Remove the System Disk and insert the Backup Disk (or Backup Disk I). Then type any character. CP/M will display:

A>

With the Backup Disk (or Backup Disk I) in the drive, proceed to the PIP activity.

PIP

This PIP activity helps you to copy the file "CONFIGUR.COM" to your System Disk. Begin this activity with Backup Disk I in the drive.

1. At the A> prompt, type the following command line:

A>**PIP B: = A:CONFIGUR.COM RETURN**

2. Assign the following identities to your disks:

"DISK A" is Backup Disk I; and
"DISK B" is the System Disk.

4. When prompted, insert the appropriate disk in the drive, close the drive, and press **RETURN**.

When the file CONFIGUR.COM has been copied, CP/M will display the A> system prompt. You should end up with Backup Disk I in the drive.

Proceed to the MAKEBIOS activity.

MAKEBIOS

The MAKEBIOS activity helps you to modify the CP/M Operating System so that it can control your secondary drive group. The method you use to operate MAKEBIOS depends on the type of CP/M backup media you have. Use only one of the two MAKEBIOS methods specified below:

If you have three CP/M Backup Disks recorded on 48 TPI disks (hard-sectored or soft-sectored), then use Method A to MAKEBIOS and follow the numbered steps preceded by the letter A.

If you have a single CP/M Backup Disk recorded on a soft-sectored 96 TPI disks, then use Method B to MAKEBIOS and follow the numbered steps preceded by the letter B.

Method A

- A1. At the A> system prompt, type the following command line to run MAKEBIOS:

A>SUBMIT B:MAKEBIOS C: B: RETURN

The MAKEBIOS utility will display the following:

PUT DISK B IN DRIVE A: AND PRESS RETURN

NOTE: The Method A MAKEBIOS activity requires many disk switches and several minutes of execution time. Be patient, keep track of disk identities, and watch the prompts carefully!

You will be prompted to insert three different disks into the drive alternately. The prompts will request your disks by the following names:

Backup Disk I is "DISK A";
Backup Disk III is "DISK B"; and
the System Disk is "DISK C".

- A2. As prompted, insert Backup Disk III ("DISK B") and press **RETURN**. MAKEBIOS will now display the prompt:

PUT DISK A IN DRIVE A: AND PRESS RETURN

- A3. Insert Backup Disk I ("DISK A") in the drive, close the drive, and press **RETURN**. MAKEBIOS will display the following command line and prompt:

```
A>B: MAKEBIOS B: 1 C:  
PUT DISK B IN DRIVE A: AND PRESS RETURN
```

- A4. Insert Backup Disk III ("DISK B") in the drive and press **RETURN**. MAKEBIOS will display:

```
PUT DISK C IN DRIVE A: AND PRESS RETURN
```

- A5. Insert the System Disk ("DISK C") and press **RETURN**. MAKEBIOS will display:

```
PUT DISK A IN DRIVE A: AND PRESS RETURN
```

- A6. Insert Backup Disk I ("DISK A") in the drive and press **RETURN**. MAKEBIOS will display:

```
PUT DISK B IN DRIVE A: AND PRESS RETURN
```

- A7. Insert Backup Disk III ("DISK B") in the drive and press **RETURN**. MAKEBIOS will now display the following menu:

```
BIOS SELECTION MENU
```

```
A -- H17 ONLY  
B -- H37 ONLY  
C -- H47 ONLY  
D -- H67 ONLY  
E -- H17 AND H37  
F -- H17 AND H47  
G -- H17 AND H67  
H -- H37 AND H47  
I -- H37 AND H67  
J -- H47 AND H67
```

```
ENTER SELECTION?
```

A8. At the "ENTER SELECTION?" prompt, type a selection letter as advised below:

- If you have two different kinds of disk drive, accommodating both 5.25-inch hard-sectored disks and 5.25-inch soft-sectored disks, type **E RETURN**.
- If you have two different kinds of disk drive, accommodating both 5.25-inch hard-sectored disks and 8-inch disks, type **F RETURN**.
- If you have two different kinds of disk drive, accommodating both 5.25-inch hard-sectored disks and the H/Z67 Winchester drive model, type **G RETURN**.
- If you have two different kinds of disk drive, accommodating both 5.25-inch soft-sectored disks and 8-inch disks, type **H RETURN**.
- If you have two different kinds of disk drive, accommodating both 5.25-inch soft-sectored disks and the H/Z67 Winchester drive model, type **I RETURN**.

Type a selection letter, and switch disks as instructed.

A9. Insert "DISK A" or "DISK B" or "DISK C" as indicated, whenever MAKEBIOS displays a prompt in the form:

```
PUT DISK C IN DRIVE A: AND PRESS RETURN
```

NOTE: In between these prompts, you will notice that seven command lines are displayed at the terminal. When the execution of these command lines is complete, MAKEBIOS displays the message:

```
MAKEBIOS FUNCTION COMPLETE
```

```
PUT DISK A IN DRIVE A: AND PRESS RETURN
```

Insert Backup Disk I ("DISK A") in the drive and press return. CP/M will display the A> system prompt. Proceed to the MOVCPM activity.

Method B

- B1. At the A> system prompt, type the following command line to run MAKEBIOS:

A>SUBMIT MAKEBIOS B: RETURN

The MAKEBIOS utility will display prompts in the following form:

PUT DISK B IN DRIVE A: AND PRESS RETURN

NOTE: The Method B MAKEBIOS activity requires many disk switches and several minutes of execution time. Be patient, keep track of disk identities, and watch the prompts carefully!

You will be prompted to insert two different disks into the drive alternately. The prompts will request your disks by the following names:

the Backup Disk is "DISK A"; and
the System Disk is "DISK B".

- B2. When prompted to "PUT DISK B", insert the System Disk in the drive and press **RETURN**.

When prompted to "PUT DISK A", insert the Backup Disk in the drive and press **RETURN**.

Eventually, MAKEBIOS will now display the following menu:

BIOS SELECTION MENU

A -- H17 ONLY
B -- H37 ONLY
C -- H47 ONLY
D -- H67 ONLY
E -- H17 AND H37
F -- H17 AND H47
G -- H17 AND H67
H -- H37 AND H47
I -- H37 AND H67
J -- H47 AND H67

ENTER SELECTION?

B3. At the "ENTER SELECTION?" prompt, type a selection letter as advised below:

- If you have two different kinds of disk drive, accommodating both 5.25-inch hard-sectored disks and 5.25-inch soft-sectored disks, then type **E RETURN**.
- If you have two different kinds of disk drive, accommodating both 5.25-inch hard-sectored disks and 8-inch disks, then type **F RETURN**.
- If you have two different kinds of disk drive, accommodating both 5.25-inch hard-sectored disks and the H/Z67 Winchester drive model, then type **G RETURN**.
- If you have two different kinds of disk drive, accommodating both 5.25-inch soft-sectored disks and 8-inch disks, then type **H RETURN**.
- If you have two different kinds of disk drive, accommodating both 5.25-inch soft-sectored disks and the H/Z67 Winchester drive model, then type **I RETURN**.

MAKEBIOS will again display the "PUT DISK A" and "PUT DISK B" prompts. MAKEBIOS will also cause the automatic display of several other messages. Until the MAKEBIOS function is complete, ignore all displays other than the "PUT DISK" prompts.

B4. When prompted to "PUT DISK B", insert the System Disk in the drive and press **RETURN**.

When prompted to "PUT DISK A", insert the Backup Disk in the drive and press **RETURN**.

After you swap the Backup and System Disks several times, MAKEBIOS will display the message "MAKEBIOS FUNCTION COMPLETE" and a "PUT DISK A" prompt as shown:

MAKEBIOS FUNCTION COMPLETE

PUT DISK A IN DRIVE A: AND PRESS RETURN

B5. Insert the Backup Disk ("DISK A") in the drive and press **RETURN**. CP/M will display the A> system prompt.

Proceed to the MOVCPM activity.

MOVCPM

The MOVCPM utilities enable you to adjust the amount of memory space that your CP/M Operating System will occupy in your microcomputer. Your computer has a memory limit of either 32K, 48K, or 64K. However, your operating system is preset to occupy only 32K. ("K" stands for kilobyte, a unit of computer storage space.)

MOVCPM loads part of the operating system into a special location in computer memory, and allows it to expand until it fills the computer's entire memory capacity.

1. If your System Disk is hard-sectored, then enter the following command in response to the system prompt:

```
A>MOVCPM17 * C:
```

If your System Disk is soft-sectored, then enter the following command in response to the system prompt:

```
A>MOVCPM37 * C:
```

After one of these commands, MOVCPM will display a message in the following form:

```
MOVCPM17 VERSION 2.2.04
```

```
CONSTRUCTING nnK CP/M VERS 2.2
```

```
PUT DISK C IN DRIVE A: AND PRESS RETURN
```

2. Insert the System Disk ("DISK C") and press **RETURN**. MOVCPM will display a message in the form:

```
READY FOR "SYSGEN" OR
```

```
"SAVE 38 CPMnn.COM"
```

```
PUT DISK A IN DRIVE A: AND PRESS RETURN
```

3. Insert Backup Disk I ("DISK A") and press **RETURN**. This entry exits you from the MOVCPM utility. CP/M now displays the system prompt:

```
A>
```

Proceed immediately to the SYSGEN activity.

SYSGEN

The SYSGEN utility copies part of the CP/M Operating System onto your System Disk. SYSGEN will get this operating system copy from a special location in computer memory. (A MOVCPM activity put part of the operating system in this special memory location.) Backup Disk I should be in the drive to begin this activity.

1. At the A> prompt, type **SYSGEN** and press **RETURN**. This entry invokes the SYSGEN utility, which displays the message:

```
SYSGEN VER 2.0.04  
SOURCE DRIVE NAME (OR RETURN TO SKIP):
```

2. Press **RETURN** as shown above. SYSGEN will display:

```
DESTINATION DRIVE NAME (OR RETURN TO REBOOT):
```

3. Type **C**. SYSGEN will display:

```
DESTINATION ON C, THEN TYPE RETURN
```

4. Type **RETURN**. SYSGEN will display the following prompt:

```
PUT DISK C IN DRIVE A: AND PRESS RETURN
```

5. Remove Backup Disk I and insert your System Disk. Then press **RETURN**. SYSGEN will display:

```
FUNCTION COMPLETE.  
DESTINATION DRIVE NAME (OR RETURN TO REBOOT):
```

6. Reset the computer. Do **not** press **RETURN** at this prompt.

Proceed to the CONFIGUR activity.

CONFIGUR

This CONFIGUR activity customizes the operating system on your System Disk to match several characteristics of your hardware environment. This procedure will show you how to use CONFIGUR to customize the system only for essential hardware characteristics. (Use the CONFIGUR instructions in the Volume II: The CP/M Reference Guide if you want more detailed instructions on using CONFIGUR.)

To prepare for this activity, insert your System Disk in the drive slot.

1. Perform bootstrap. The CONFIGUR utility should be invoked automatically. It will present a display that begins with a message in the following form:

```
Heath/Zenith Configuration Program
Version 2.2.04
Serial Number: sss-sssss
```

CONFIGUR will continue to display messages, ending with the following prompt:

```
Standard system (Y or N)? <Y>:
```

2. Type N. CONFIGUR will display a selection menu labelled "CP/M Configuration".
3. Refer to Table 1-21 if you have a Z89-3 interface card, and to Table 1-22 if you have a Z89-11 interface card. Using the appropriate table, type the keyboard entries listed for your terminal. To the right of each entry is an excerpt or description of part of the display that should appear immediately **after** you type the entry. If the excerpted or described display in the table does not appear on your terminal, repeat the entry.

NOTE: Type only the capital letters or numbers featured in bold faced type beneath the heading "Keyboard Entries". Do not change the order of the entries listed. If you type an incorrect entry at a prompt, CONFIGUR will either ignore your mistake, or display it. If a mistake is ignored, simply answer the prompt again. If CONFIGUR displays your mistake, you can usually change it by typing **Z** and repeating a few entries.

Your Terminal	Keyboard Entries	Excerpt or Description of Desired Display
Zenith or Heath Z-19, H-19, Z-88, H-88, Z-89, H-89, or Z-90 terminal	A A 9 350 Y C A CRT Y	(Terminal and Printer Characteristics – Submenu A) CRT: baud rate: CRT: baud rate: 9600 port: CRT: baud rate: 9600 port: 0E8H = 350Q CP/M Configuration (Main Menu) (Default I/O Configuration – Submenu C) CRT: = CON: = CRT: CP/M Configuration (Main Menu)
DECwriter LA-34 or LA-36 terminal	A B 30 320 Y C A TTY Y	(Terminal and Printer Characteristics – Submenu A) TTY: baud rate: TTY: baud rate: 300 port: TTY: baud rate: 300 port: 0D0H = 320Q CP/M Configuration (Main Menu) (Default I/O Configuration – Submenu C) CON: = CON: = TTY: CP/M Configuration (Main Menu)
Diablo KSR 1640 terminal	A B 12 320 Y C A TTY Y	(Terminal and Printer Characteristics – Submenu A) TTY: baud rate: TTY: baud rate: 1200 port: TTY: baud rate: 1200 port: 0D0H = 320Q CP/M Configuration (Main Menu) (Default I/O Configuration – Submenu C) CON: = CON: = TTY: CP/M Configuration (Main Menu)

Table 1-21
Terminals with Z89-3 Interface

Your Terminal	Keyboard Entries	Excerpt or Description of Desired Display
Zenith or Heath Z-19, H-19, Z-88, H-88, Z-89, H-89, or Z-90 terminal	A A 9 350 Y C A CRT Y	(Terminal and Printer Characteristics – Submenu A) CRT: baud rate: CRT: baud rate: 9600 port: CRT: baud rate: 9600 port: 0E8H = 350Q CP/M Configuration (Main Menu) (Default I/O Configuration – Submenu C) CRT: = CON: = CRT: CP/M Configuration (Main Menu)
DECwriter LA-34 or LA-36 terminal	A B 30 330 Y C A TTY Y	(Terminal and Printer Characteristics – Submenu A) TTY: baud rate: TTY: baud rate: 300 port: TTY: baud rate: 300 port: 0D8H = 330Q CP/M Configuration (Main Menu) (Default I/O Configuration – Submenu C) CON: = CON: = TTY: CP/M Configuration (Main Menu)
Diablo KSR 1640 terminal	A B 12 330 Y C A TTY Y	(Terminal and Printer Characteristics – Submenu A) TTY: baud rate: TTY: baud rate: 1200 port: TTY: baud rate: 1200 port: 0D8H = 330Q CP/M Configuration (Main Menu) (Default I/O Configuration – Submenu C) CON: = CON: = TTY: CP/M Configuration (Main Menu)

Table 1-22

Terminals with Z89-11 Interface

- Refer to Table 1-23 if you have a Z89-3 interface card, and to Table 1-24 if you have a Z89-11 interface card. Using the appropriate table, type the keyboard entries listed for your printer. To the right of each entry is an excerpt or description of part of the display that should appear immediately **after** you type the entry. If the excerpted or described display in the table does not appear, repeat the entry.

Your Printer	Keyboard Entries	Excerpt or Description of Desired Display
Diablo 630, 1640, or 1650 printer	A C 12 340 none none Y C D UL1 Y	(Terminal and Printer Characteristics – Submenu A) LST: baud rate: LST: baud rate: 1200 port: LST: baud rate: 1200 port: 0E0H = 340Q Serial Printer Ready Signal Polarity: LOW Serial Printer Ready Signal: RTS (Pin 4) CP/M Configuration (Main Menu) (Default I/O Configuration – Submenu C) LST: = LST: = UL1: CP/M Configuration (Main Menu)
DECwriter LA-34 or LA-36 printer	A C 30 340 none none Y C D LPT Y	(Terminal and Printer Characteristics – Submenu A) LST: baud rate: LST: baud rate: 300 port: LST: baud rate: 300 port: 0E0H = 340Q Serial Printer Ready Signal Polarity: LOW Serial Printer Ready Signal: RTS (Pin 4) CP/M Configuration (Main Menu) (Default I/O Configuration – Submenu C) LST: = LST: = LPT: CP/M Configuration (Main Menu)
Heath H-14 printer	A C 4 340 none none Y C D LPT Y	(Terminal and Printer Characteristics – Submenu A) LST: baud rate: LST: baud rate: 4800 port: LST: baud rate: 4800 port: 0E0H = 340Q Serial Printer Ready Signal Polarity: LOW Serial Printer Ready Signal: RTS (Pin 4) CP/M Configuration (Main Menu) (Default I/O Configuration – Submenu C) LST: = LST: = LPT: CP/M Configuration (Main Menu)

Table 1-23
Printers with Z89-3 Interface
(continued on next page)

Your Printer	Keyboard Entries	Excerpt or Description of Desired Display
Texas Instruments TI-810 printer	A C 4 340 none none Y C D LPT Y	(Terminal and Printer Characteristics – Submenu A) LST: baud rate: LST: baud rate: 4800 port: LST: baud rate: 4800 port: 0E0H = 340Q Serial Printer Ready Signal Polarity: LOW Serial Printer Ready Signal: RTS (Pin 4) CP/M Configuration (Main Menu) (Default I/O Configuration – Submenu C) LST: = LST: = LPT: CP/M Configuration (Main Menu)
Zenith or Heath Z-25 or H-25 printer	A C 4 340 M none Y C D LPT Y	(Terminal and Printer Characteristics – Submenu A) LST: baud rate: LST: baud rate: 4800 port: LST: baud rate: 4800 port: 0E0H = 340Q Serial Printer Ready Signal Polarity: HIGH Serial Printer Ready Signal: RTS (Pin 4) CP/M Configuration (Main Menu) (Default I/O Configuration – Submenu C) LST: = LST: = LPT: CP/M Configuration (Main Menu)
Epson MX-80 serial printer	A C 4 340 M N Y C D LPT Y	(Terminal and Printer Characteristics – Submenu A) LST: baud rate: LST: baud rate: 4800 port: LST: baud rate: 4800 port: 0E0H = 340Q Serial Printer Ready Signal Polarity: HIGH Serial Printer Ready Signal: DTR (Pin 20) CP/M Configuration (Main Menu) (Default I/O Configuration – Submenu C) LST: = LST: = LPT: CP/M Configuration (Main Menu)

Table 1-23
Printers with Z89-3 Interface
(continued from preceding page)

Your Printer	Keyboard Entries	Excerpt or Description of Desired Display
Diablo 630, 1640, or 1650 printer	A C 12 340 none none Y C D UL1 Y	(Terminal and Printer Characteristics – Submenu A) LST: baud rate: LST: baud rate: 1200 port: LST: baud rate: 1200 port: OE0H = 340Q Serial Printer Ready Signal Polarity: LOW Serial Printer Ready Signal: RTS (Pin 4) CP/M Configuration (Main Menu) (Default I/O Configuration – Submenu C) LST: = LST: = UL1: CP/M Configuration (Main Menu)
DECwriter LA-34 or LA-36 printer	A C 30 340 none none P Y C D LPT Y	(Terminal and Printer Characteristics – Submenu A) LST: baud rate: LST: baud rate: 300 port: LST: baud rate: 300 port: OE0H = 340Q Serial Printer Ready Signal Polarity: LOW Serial Printer Ready Signal: RTS (Pin 4) Z89-11 LPT Selection: SERIAL CP/M Configuration (Main Menu) (Default I/O Configuration – Submenu C) LST: = LST: = LPT: CP/M Configuration (Main Menu)
Heath H-14 printer	A C 4 340 none none P Y C D LPT Y	(Terminal and Printer Characteristics – Submenu A) LST: baud rate: LST: baud rate: 4800 port: LST: baud rate: 4800 port: OE0H = 340Q Serial Printer Ready Signal Polarity: LOW Serial Printer Ready Signal: RTS (Pin 4) Z89-11 LPT Selection: SERIAL CP/M Configuration (Main Menu) (Default I/O Configuration – Submenu C) LST: = LST: = LPT: CP/M Configuration (Main Menu)

Table 1-24
Printers with Z89-11 Interface
(continued on next page)

Your Printer	Keyboard Entries	Excerpt or Description of Desired Display
Texas Instruments TI-810 printer	A C 4 340 none none P Y C D LPT Y	(Terminal and Printer Characteristics – Submenu A) LST: baud rate: LST: baud rate: 4800 port: LST: baud rate: 4800 port: 0E0H = 340Q Serial Printer Ready Signal Polarity: LOW Serial Printer Ready Signal: RTS (Pin 4) Z89-11 LPT Selection: SERIAL CP/M Configuration (Main Menu) (Default I/O Configuration – Submenu C) LST: = LST: = LPT: CP/M Configuration (Main Menu)
Zenith or Heath Z-25 or H-25 printer	A C 4 340 M none P Y C D LPT Y	(Terminal and Printer Characteristics – Submenu A) LST: baud rate: LST: baud rate: 4800 port: LST: baud rate: 4800 port: 0E0H = 340Q Serial Printer Ready Signal Polarity: HIGH Serial Printer Ready Signal: RTS (Pin 4) Z89-11 LPT Selection: SERIAL CP/M Configuration (Main Menu) (Default I/O Configuration – Submenu C) LST: = LST: = LPT: CP/M Configuration (Main Menu)
Epson MX-80 serial printer	A C 4 340 M N P Y C D LPT Y	(Terminal and Printer Characteristics – Submenu A) LST: baud rate: LST: baud rate: 4800 port: LST: baud rate: 4800 port: 0E0H = 340Q Serial Printer Ready Signal Polarity: HIGH Serial Printer Ready Signal: DTR (Pin 20) Z89-11 LPT Selection: SERIAL CP/M Configuration (Main Menu) (Default I/O Configuration – Submenu C) LST: = LST: = LPT: CP/M Configuration (Main Menu)

Table 1-24

Printers with Z89-11 Interface

(continued on next page)

Your Printer	Keyboard Entries	Excerpt or Description of Desired Display
Epson MX-80 parallel printer	A none none Y C D LPT Y	(Terminal and Printer Characteristics – Submenu A) Parallel Printer Ready Signal Polarity: HIGH Z89-11 LPT Selection: PARALLEL CP/M Configuration (Main Menu) (Default I/O Configuration – Submenu C) LST: = LST: = LPT: CP/M Configuration (Main Menu)

Table 1-24

Printers with Z89-11 Interface
 (continued from preceding page)

5. If your primary drive group consists of a 96 TPI drive, type the sequence of keyboard entries listed in Table 1-25. To the right of each entry is an excerpt or description of the part of the display that should appear immediately **after** you type the entry.

Keyboard Entries	Excerpt or Description of Desired Display
B A 6 RETURN 96 RETURN Y	5.25 Inch Soft Sector Unit 0 Step Rate: 30ms Track Density: 48tpi 5.25 Inch Soft Sector Unit 1 Step Rate: 30ms Track Density: 48tpi 5.25 Inch Soft Sector Unit 2 Step Rate: 30ms Track Density: 48tpi Soft Sector Unit 0 Step Rate ? Soft Sector Unit 0 Step Rate ? 6 Soft Sector Unit 0 Track Density ? Soft Sector Unit 0 Track Density ? 96 5.25 Inch Soft Sector Unit 0 Step Rate: 6ms Track Density: 96tpi 5.25 Inch Soft Sector Unit 1 Step Rate: 30ms Track Density: 48tpi 5.25 Inch Soft Sector Unit 2 Step Rate: 30ms Track Density: 48tpi CP/M Configuration (Main Menu)

Table 1-25

CONFIGUR Entries for One Primary 96 TPI Drive

If your primary drive group consists of a 48 TPI drive, then proceed to step 6.

6. If your secondary drive group consists of any 96 TPI drives, type the sequence of keyboard entries listed in Table 1-26. To the right of each entry is an excerpt or description of the part of the display that should appear immediately **after** you type the entry.

Keyboard Entries	Excerpt or Description of Desired Display
<p>B</p> <p>A</p> <p>6</p> <p>RETURN</p> <p>96</p> <p>RETURN</p> <p>B</p> <p>6</p> <p>RETURN</p> <p>96</p> <p>RETURN</p> <p>C</p> <p>6</p> <p>RETURN</p> <p>96</p> <p>RETURN</p> <p>Y</p>	<p>5.25 Inch Soft Sector Unit 0 Step Rate: 30ms Track Density: 48tpi</p> <p>5.25 Inch Soft Sector Unit 1 Step Rate: 30ms Track Density: 48tpi</p> <p>5.25 Inch Soft Sector Unit 2 Step Rate: 30ms Track Density: 48tpi</p> <p>Soft Sector Unit 0 Step Rate ?</p> <p>Soft Sector Unit 0 Step Rate ? 6</p> <p>Soft Sector Unit 0 Track Density ?</p> <p>Soft Sector Unit 0 Track Density ? 96</p> <p>5.25 Inch Soft Sector Unit 0 Step Rate: 6ms Track Density: 96tpi</p> <p>5.25 Inch Soft Sector Unit 1 Step Rate: 30ms Track Density: 48tpi</p> <p>5.25 Inch Soft Sector Unit 2 Step Rate: 30ms Track Density: 48tpi</p> <p>Soft Sector Unit 1 Step Rate ?</p> <p>Soft Sector Unit 1 Step Rate ? 6</p> <p>Soft Sector Unit 1 Track Density ?</p> <p>Soft Sector Unit 1 Track Density ? 96</p> <p>5.25 Inch Soft Sector Unit 0 Step Rate: 6ms Track Density: 96tpi</p> <p>5.25 Inch Soft Sector Unit 1 Step Rate: 6ms Track Density: 96tpi</p> <p>5.25 Inch Soft Sector Unit 2 Step Rate: 30ms Track Density: 48tpi</p> <p>Soft Sector Unit 2 Step Rate ?</p> <p>Soft Sector Unit 2 Step Rate ? 6</p> <p>Soft Sector Unit 2 Track Density ?</p> <p>Soft Sector Unit 2 Track Density ? 96</p> <p>5.25 Inch Soft Sector Unit 0 Step Rate: 6ms Track Density: 96tpi</p> <p>5.25 Inch Soft Sector Unit 1 Step Rate: 6ms Track Density: 96tpi</p> <p>5.25 Inch Soft Sector Unit 2 Step Rate: 6ms Track Density: 96tpi</p> <p>CP/M Configuration (Main Menu)</p>

Table 1-26
CONFIGUR Entries for Secondary 96 TPI Drive

If your secondary drive group does not consist of any 96 TPI drives, then proceed to Step 7.

7. CONFIGUR should now display the selection menu labelled "CP/M Configuration". Respond to the selection prompt in this menu by typing **Y**. CP/M will display the "A>" system prompt.
8. We suggest that you now test the operating system on your System Disk to make sure that it properly controls your terminal, printer, modem, drives, etc. (For instance, you can test a printer by holding down the **CTRL** key while pressing the **P** key, and then entering a **RETURN**. A properly adjusted system will cause the printer to print an A> system prompt.)

If the operating system on your System Disk proves to be adequate, proceed to the ERA activity.

NOTE: If you have any hardware devices that are **not** listed in these tables and are still not working with your System Disk, then use the instructions in Volume II: The CP/M Reference Guide to perform the CONFIGUR activity.

If you have devices that are listed in these tables and they still don't function properly with your System Disk, then the devices themselves might have been set with characteristics that this text could not anticipate. Therefore you should refer to your hardware manual(s) for hardware settings instructions, and to Volume II: The CP/M Reference Guide for CONFIGUR instructions.

ERA

This activity helps you to erase the CONFIGUR utility from your System Disk to allow you more space to record useful application programs. However, this activity is optional. If you wish to perform the CONFIGUR activity again or if you would prefer to keep CONFIGUR recorded on your System Disk, then skip this activity.

To perform the ERA activity, the System Disk should be in the drive, and the A> system prompt should be displayed on the terminal. At the A> system prompt, type the following command:

A>ERA CONFIGUR.COM RETURN

You have just completed the last step of the last activity of your customization procedure.

If you correctly followed your entire customization procedure, your System Disk should contain a copy of the CP/M Operating System that controls all components of your hardware environment.

To combine this customized operating system with an application program, proceed to the "Working Disk Procedures".

Customizing Procedure Five

Two or Three Primary Floppy Drives, and One or More Secondary Drives

This procedure will help you to customize a copy of the CP/M Operating System taken from your Backup Disk (or Backup Disk I), and put this customized system copy on a blank disk. The blank disk must be manufactured the same type as the Backup Disk, although you can FORMAT the blank to any density or number of sides that the FORMAT utility allows. Label this blank disk "System Disk".

All disks must be write-enabled during this procedure.

PROCEDURE SYNOPSIS

This procedure requires you to perform the following activities in sequence:

```
bootstrap
CONFIGUR
FORMAT
MAKEBIOS
MOVCPM*
SYSGEN
bootstrap
CONFIGUR
```

To begin Customizing Procedure Five, insert the Backup Disk (or Backup Disk I) in drive A and the System Disk in drive B. Perform bootstrap. The CONFIGUR utility will be invoked automatically. Proceed to the CONFIGUR activity.

* Use either MOVCPM17 or MOVCPM37 or MOVCPM47.

CONFIGUR

This CONFIGUR activity customizes the operating system that you placed in memory when you performed bootstrap so that you can copy data to your backup disk(s). There are two methods for performing this CONFIGUR activity, so use **ONLY** the method specified below for your primary drive group (the group containing your bootstrap drive.

If your primary drives are 48 TPI drives, then use Method A for this CONFIGUR activity.

If your primary drives are 96 TPI drives, then use Method B for this CONFIGUR activity.

Method A

When the CONFIGUR utility is automatically invoked, it will display several messages. When CONFIGUR displays the message:

```
STANDARD SYSTEM (Y OR N)? <Y>:
```

type **Y**. The CONFIGUR activity will end, and CP/M will display the **A>** system prompt.

Proceed to the FORMAT activity.

Method B

When the CONFIGUR utility is automatically invoked, it will display several messages. When CONFIGUR displays the message:

```
STANDARD SYSTEM (Y OR N)? <Y>:
```

type the sequence of keyboard entries listed in Table 1-27. To the right of each entry is an excerpt or description of the part of the display that should appear immediately **after** your entry.

Keyboard Entries	Excerpt or Description of Desired Display
N	CP/M Configuration (Main Menu)
B	5.25 Inch Soft Sector Unit 0 Step Rate: 30ms Track Density: 48tpi
	5.25 Inch Soft Sector Unit 1 Step Rate: 30ms Track Density: 48tpi
	5.25 Inch Soft Sector Unit 2 Step Rate: 30ms Track Density: 48tpi
A	Soft Sector Unit 0 Step Rate ?
6	Soft Sector Unit 0 Step Rate ? 6
RETURN	Soft Sector Unit 0 Track Density ?
96	Soft Sector Unit 0 Track Density ? 96
RETURN	5.25 Inch Soft Sector Unit 0 Step Rate: 6ms Track Density: 96tpi
	5.25 Inch Soft Sector Unit 1 Step Rate: 30ms Track Density: 48tpi
	5.25 Inch Soft Sector Unit 2 Step Rate: 30ms Track Density: 48tpi
B	Soft Sector Unit 1 Step Rate ?
6	Soft Sector Unit 1 Step Rate ? 6
RETURN	Soft Sector Unit 1 Track Density ?
96	Soft Sector Unit 1 Track Density ? 96
RETURN	5.25 Inch Soft Sector Unit 0 Step Rate: 6ms Track Density: 96tpi
	5.25 Inch Soft Sector Unit 1 Step Rate: 6ms Track Density: 96tpi
	5.25 Inch Soft Sector Unit 2 Step Rate: 30ms Track Density: 48tpi
C	Soft Sector Unit 2 Step Rate ?
6	Soft Sector Unit 2 Step Rate ? 6
RETURN	Soft Sector Unit 2 Track Density ?
96	Soft Sector Unit 2 Track Density ? 96
RETURN	5.25 Inch Soft Sector Unit 0 Step Rate: 6ms Track Density: 96tpi
	5.25 Inch Soft Sector Unit 1 Step Rate: 6ms Track Density: 96tpi
	5.25 Inch Soft Sector Unit 2 Step Rate: 6ms Track Density: 96tpi
Y	CP/M Configuration (Main Menu)
Y	A> (CP/M system prompt)

Table 1-27
CONFIGUR Entries for 96 TPI Drive

When the A> system prompt appears, proceed to the FORMAT activity.

NOTE: If the display excerpted or described in the table does not appear, read the CONFIGUR text in "Volume II: The CP/M Reference Guide".

FORMAT

The FORMAT utility prepares your System Disk for data storage. However, FORMAT works differently depending on the type of disk you are using. Therefore, use the FORMAT method specified below:

If your System Disk is hard-sectored, use Method A to FORMAT and follow the numbered steps preceded by the letter A.

If your System Disk is soft-sectored, use Method B to FORMAT and follow the numbered steps preceded by the letter B.

Method A:

- A1. At the A> system prompt, type **FORMAT** and press **RETURN**. This entry invokes FORMAT, which displays the message:

```
Format Version 2.04
This program is used to initialize a disk.
All information currently on the disk will be destroyed.
Is that what you want? (y/n):
```

- A2. Type **Y**. FORMAT will display:

```
Which drive do you wish to use for this operation?
```

- A3. Type **B**. FORMAT will display:

```
Put the disk you wish to be formatted in drive B.
Press RETURN to begin, anything else to abort.
```

- A4. Make sure that the System Disk is properly situated in drive B, and press **RETURN**. The light on the disk drive will glow for several seconds. Then FORMAT will display:

```
Do you have more disks to format? (y/n):
```

- A5. Type **N**. CP/M will display:

```
A>
```

Proceed to the MAKEBIOS activity.

Method B:

- B1. At the CP/M prompt A>, type **FORMAT** and press **RETURN**. This entry invokes FORMAT, which displays the following:

```
Format Version 2.04
This program is used to initialize a disk.
All information currently on the disk will be destroyed.
Is that what you want? (y/n):
```

- B2. Type **Y**. FORMAT will display:

```
Which drive do you wish to use for this operation?
```

- B3. Type **B**. FORMAT will display one of the following two messages:

```
Which density? (S=single, D=double):
```

or

```
Which density? (S=single, D=double, E=extended):
```

- B4. If your System Disk is a single-density disk, type **S**.

If your System Disk is a double-density disk, type **D**.

- B5. After you respond to the density prompt, FORMAT will operate differently, depending on the physical size of your System Disk.

If your System Disk is an 8-inch disk, proceed immediately to Step B7.

If your System Disk is a 5.25 inch soft-sectored disk, FORMAT will now display:

```
Number of sides? (1=single, 2=double):
```

B6. If your System Disk is a single-sided disk, type **1**.

If your System Disk is a double-sided disk, type **2**.

After you respond to the side quantity prompt, **FORMAT** will display one of the following two messages:

48 TPI drive -- 40 tracks will be formatted

OR

96 TPI drive -- 80 tracks will be formatted

(If the type of TPI drive specified here does not match your drives, repeat the previous **CONFIGUR** activity.)

B6. After you have specified either the density or number of sides for your System Disk, **FORMAT** will display the following prompt:

Put the disk you wish to be formatted in drive B.
Press **RETURN** to begin, anything else to abort.

B7. Make sure that the System Disk is properly situated in drive B, and press **RETURN**. The light on the disk drive will glow for several seconds. Then **FORMAT** will display:

Do you have more disks to format? (y/n):

B8. Type **N**. **CP/M** will display:

A>

Proceed to the **MAKEBIOS** activity.

MAKEBIOS

The MAKEBIOS utility helps you to modify the CP/M Operating System so that it can control your secondary drive group.

1. If your System Disk is a 48 TPI, 5.25-inch disk and you have three 48 TPI, 5.25-inch drives, then insert Backup Disk I into drive A:, the System Disk into drive B:, and Backup Disk III into drive C:. Then at the "A>" system prompt, type the following command line to run MAKEBIOS:

A>SUBMIT C:MAKEBIOS B: C: RETURN

If your System Disk is a 48 TPI, 5.25-inch disk and you have two 48 TPI, 5.25-inch drives, then insert Backup Disk I into drive A, and the System Disk into drive B. Throughout this activity, you will be prompted to switch Backup Disk I and Backup Disk III in and out of the same drive slot alternately. When prompted to switch disks, insert Backup Disk I as "DISK A" and Backup Disk III will be "DISK C". At the "A>" system prompt, type the following command line to run MAKEBIOS:

A>SUBMIT C:MAKEBIOS B: C: RETURN

If your Systemn Disk is an 8-inch disk or a 96 TPI, 5.25-inch disk, insert the Backup Disk into drive A: and the System Disk into drive B: Then, at the A> system prompt, type the following command line to run MAKEBIOS:

A>SUBMIT MAKEBIOS B: RETURN

The MAKEBIOS utility will display a menu in the following form:

BIOS SELECTION MENU

```
A -- H17 ONLY
B -- H37 ONLY
C -- H47 ONLY
D -- H67 ONLY
E -- H17 AND H37
F -- H17 AND H47
G -- H17 AND H67
H -- H37 AND H47
I -- H37 AND H67
J -- H47 AND H67
```

ENTER SELECTION:

2. At the "ENTER SELECTION:" prompt, type a selection letter based on the following criteria:
 - If you have two different kinds of disk drive, accommodating both 5.25-inch hard-sectored disks and 5.25-inch soft-sectored disks, type **E RETURN**.
 - If you have two different kinds of disk drive, accommodating both 5.25-inch hard-sectored disks and 8-inch disks, type **F RETURN**.
 - If you have two different kinds of disk drive, accommodating both 5.25-inch hard-sectored disks and the H/Z67 Winchester drive model, type **G RETURN**.
 - If you have two different kinds of disk drive, accommodating both 5.25-inch soft-sectored disks and 8-inch disks, type **H RETURN**.
 - If you have two different kinds of disk drive, accommodating both 5.25-inch soft-sectored disks and the H/Z67 Winchester drive model, type **I RETURN**.
 - If you have two different kinds of disk drive, accommodating 8-inch disks in the H/Z47 drive model and H/Z67 Winchester drive model, type **J RETURN**.

After you type one of the selection letters and a carriage return, your terminal will automatically display seven command lines and other messages. These displays will appear for the next few minutes.

If your System Disk is a 48 TPI, 5.25-inch disk and you have two 48 TPI, 5.25-inch drives, then prompts in the following form will be displayed throughout this activity:

PUT DISK C IN DRIVE A: AND PRESS RETURN

When a "PUT DISK C" prompt appears, insert Backup Disk III. When a "PUT DISK A" prompt appears, insert Backup Disk I. Remember that "DRIVE A:" is the drive slot you used to boot up. If these prompts appear, watch them carefully and keep track of disk identities as you insert the disks alternately.

Regardless of what kind of System Disk or hardware you have, your MAKEBIOS activity will be finished when CP/M displays the system prompt:

A>

With the Backup Disk (or Backup Disk I) in drive A and the System Disk in drive B:, proceed immediately to the MOVCPM activity.

MOVCPM

The MOVCPM utilities load part of the operating system into a special location in computer memory, where adjustments are made to it. You must follow a MOVCPM activity with a SYSGEN activity. Begin this activity with the Backup Disk (or Backup Disk I) in drive A:, and the System Disk in drive B:.

1. If you are customizing a 5.25-inch hard-sectored System Disk, then enter the following command in response to the system prompt:

A>**MOVCPM17 * B:**

If you are customizing a 5.25-inch soft-sectored System Disk, then enter the following command in response to the system prompt:

A>**MOVCPM37 * B:**

If you are customizing an 8-inch System Disk, then enter the following command in response to the system prompt:

A>**MOVCPM47 * B:**

2. Wait for the MOVCPM utility to display a message in the following form:

MOVCPMxx VERSION 2.2.04

CONSTRUCTING nnK CP/M vers 2.2
READY FOR "SYSGEN" OR
"SAVE 38 CPMnn.COM"

Proceed immediately to the SYSGEN activity.

SYSGEN

The SYSGEN utility puts a copy of the CP/M Operating System on your System Disk. SYSGEN will get this operating system copy from a special location in computer memory. (MOVCPM activities put the operating system in this special memory location.) Begin this activity with Backup Disk I in drive A: and the System Disk in drive B:.

1. At the A> prompt, type **SYSGEN** and press **RETURN**. This entry invokes the SYSGEN utility, which displays a message in the form:

```
SYSGEN VER 2.0.04  
SOURCE DRIVE NAME (OR RETURN TO SKIP): RETURN
```

2. Press **RETURN** as shown above. The computer will print:

```
DESTINATION DRIVE NAME (OR RETURN TO REBOOT):
```

3. Type **B**. CP/M will respond:

```
DESTINATION ON B, THEN TYPE RETURN
```

4. Press **RETURN**. CP/M will print:

```
FUNCTION COMPLETE.  
DESTINATION DRIVE NAME (OR RETURN TO REBOOT):
```

5. Reset the computer. (Do not enter a carriage return at this prompt.)
6. Remove the Backup Disk (or Backup Disk I) from drive A:, and insert the System Disk in drive A:. Then insert the Backup Disk (or Backup Disk I) into drive B:.
7. Perform bootstrap. CP/M will display the system prompt:

```
A>
```

Proceed to the CONFIGUR activity.

CONFIGUR

The CONFIGUR utility customizes the operating system on your System Disk to match several characteristics of your hardware environment. This procedure will show you how to use CONFIGUR to customize the system only for essential hardware characteristics. (Use the CONFIGUR instructions in the Volume II: The CP/M Reference Guide if you want more detailed instructions on using CONFIGUR.)

To begin this activity, you should have your System Disk in drive A, and your Backup Disk (or Backup Disk I) in drive B.

1. Type the command **B:CONFIGUR RETURN** at the system prompt. This entry invokes CONFIGUR, which will present a display that begins with an identification message in the following form:

```
Heath/Zenith Configuration Program
Version 2.2.04
Serial Number: sss-sssss
```

CONFIGUR will continue to display messages, ending with the following prompt:

```
Standard system (Y or N)? <Y>:
```

2. Type N. CONFIGUR will display a selection menu labelled "CP/M Configuration".
3. Refer to Table 1-28 if you have a Z89-3 interface card, and to Table 1-29 if you have a Z89-11 interface card. Using the appropriate table, type the keyboard entries listed for your terminal. To the right of each entry is an excerpt or description of part of the display that should appear immediately **after** you type the entry. If the excerpted or described display in the table does not appear on your terminal, repeat the entry.

NOTE: Type only the capital letters or numbers featured in bold faced type beneath the heading "Keyboard Entries". Do not change the order of the entries listed. If you type an incorrect entry at a prompt, CONFIGUR will either ignore your mistake, or display it. If a mistake is ignored, simply answer the prompt again. If CONFIGUR displays your mistake, you can usually change it by typing **Z** and repeating a few entries.

Your Terminal	Keyboard Entries	Excerpt or Description of Desired Display
Zenith or Heath Z-19, H-19, Z-88, H-88, Z-89, H-89, or Z-90 terminal	A A 9 350 Y C A CRT Y	(Terminal and Printer Characteristics – Submenu A) CRT: baud rate: CRT: baud rate: 9600 port: CRT: baud rate: 9600 port: 0E8H = 350Q CP/M Configuration (Main Menu) (Default I/O Configuration – Submenu C) CRT: = CON: = CRT: CP/M Configuration (Main Menu)
DECwriter LA-34 or LA-36 terminal	A B 30 320 Y C A TTY Y	(Terminal and Printer Characteristics – Submenu A) TTY: baud rate: TTY: baud rate: 300 port: TTY: baud rate: 300 port: 0D0H = 320Q CP/M Configuration (Main Menu) (Default I/O Configuration – Submenu C) CON: = CON: = TTY: CP/M Configuration (Main Menu)
Diablo KSR 1640 terminal	A B 12 320 Y C A TTY Y	(Terminal and Printer Characteristics – Submenu A) TTY: baud rate: TTY: baud rate: 1200 port: TTY: baud rate: 1200 port: 0D0H = 320Q CP/M Configuration (Main Menu) (Default I/O Configuration – Submenu C) CON: = CON: = TTY: CP/M Configuration (Main Menu)

Table 1-28
Terminals with Z89-3 Interface

Your Terminal	Keyboard Entries	Excerpt or Description of Desired Display
Zenith or Heath Z-19, H-19, Z-88, H-88, Z-89, H-89, or Z-90 terminal	A A 9 350 Y C A CRT Y	(Terminal and Printer Characteristics – Submenu A) CRT: baud rate: CRT: baud rate: 9600 port: CRT: baud rate: 9600 port: 0E8H = 350Q CP/M Configuration (Main Menu) (Default I/O Configuration – Submenu C) CRT: = CON: = CRT: CP/M Configuration (Main Menu)
DECwriter LA-34 or LA-36 terminal	A B 30 330 Y C A TTY Y	(Terminal and Printer Characteristics – Submenu A) TTY: baud rate: TTY: baud rate: 300 port: TTY: baud rate: 300 port: 0D8H = 330Q CP/M Configuration (Main Menu) (Default I/O Configuration – Submenu C) CON: = CON: = TTY: CP/M Configuration (Main Menu)
Diablo KSR 1640 terminal	A B 12 330 Y C A TTY Y	(Terminal and Printer Characteristics – Submenu A) TTY: baud rate: TTY: baud rate: 1200 port: TTY: baud rate: 1200 port: 0D8H = 330Q CP/M Configuration (Main Menu) (Default I/O Configuration – Submenu C) CON: = CON: = TTY: CP/M Configuration (Main Menu)

Table 1-29
Terminals with Z89-11 Interface

- Refer to Table 1-30 if you have a Z89-3 interface card, and to Table 1-31 if you have a Z89-11 interface card. Using the appropriate table, type the keyboard entries listed for your printer. To the right of each entry is an excerpt or description of part of the display that should appear immediately **after** you type the entry. If the excerpted or described display in the table does not appear, repeat the entry.

Your Printer	Keyboard Entries	Excerpt or Description of Desired Display
Diablo 630, 1640, or 1650 printer	A C 12 340 none none Y C D UL1 Y	(Terminal and Printer Characteristics – Submenu A) LST: baud rate: LST: baud rate: 1200 port: LST: baud rate: 1200 port: OE0H = 340Q Serial Printer Ready Signal Polarity: LOW Serial Printer Ready Signal: RTS (Pin 4) CP/M Configuration (Main Menu) (Default I/O Configuration – Submenu C) LST: = LST: = UL1: CP/M Configuration (Main Menu)
DECwriter LA-34 or LA-36 printer	A C 30 340 none none Y C D LPT Y	(Terminal and Printer Characteristics – Submenu A) LST: baud rate: LST: baud rate: 300 port: LST: baud rate: 300 port: OE0H = 340Q Serial Printer Ready Signal Polarity: LOW Serial Printer Ready Signal: RTS (Pin 4) CP/M Configuration (Main Menu) (Default I/O Configuration – Submenu C) LST: = LST: = LPT: CP/M Configuration (Main Menu)
Heath H-14 printer	A C 4 340 none none Y C D LPT Y	(Terminal and Printer Characteristics – Submenu A) LST: baud rate: LST: baud rate: 4800 port: LST: baud rate: 4800 port: OE0H = 340Q Serial Printer Ready Signal Polarity: LOW Serial Printer Ready Signal: RTS (Pin 4) CP/M Configuration (Main Menu) (Default I/O Configuration – Submenu C) LST: = LST: = LPT: CP/M Configuration (Main Menu)

Table 1-30

Printers with Z89-3 Interface

(continued on next page)

Your Printer	Keyboard Entries	Excerpt or Description of Desired Display
Texas Instruments TI-810 printer	A C 4 340 none none Y C D LPT Y	(Terminal and Printer Characteristics – Submenu A) LST: baud rate: LST: baud rate: 4800 port: LST: baud rate: 4800 port: 0E0H = 340Q Serial Printer Ready Signal Polarity: LOW Serial Printer Ready Signal: RTS (Pin 4) CP/M Configuration (Main Menu) (Default I/O Configuration – Submenu C) LST: = LST: = LPT: CP/M Configuration (Main Menu)
Zenith or Heath Z-25 or H-25 printer	A C 4 340 M none Y C D LPT Y	(Terminal and Printer Characteristics – Submenu A) LST: baud rate: LST: baud rate: 4800 port: LST: baud rate: 4800 port: 0E0H = 340Q Serial Printer Ready Signal Polarity: HIGH Serial Printer Ready Signal: RTS (Pin 4) CP/M Configuration (Main Menu) (Default I/O Configuration – Submenu C) LST: = LST: = LPT: CP/M Configuration (Main Menu)
Epson MX-80 serial printer	A C 4 340 M N Y C D LPT Y	(Terminal and Printer Characteristics – Submenu A) LST: baud rate: LST: baud rate: 4800 port: LST: baud rate: 4800 port: 0E0H = 340Q Serial Printer Ready Signal Polarity: HIGH Serial Printer Ready Signal: DTR (Pin 20) CP/M Configuration (Main Menu) (Default I/O Configuration – Submenu C) LST: = LST: = LPT: CP/M Configuration (Main Menu)

Table 1-30
Printers with Z89-3 Interface
(continued from preceding page)

Your Printer	Keyboard Entries	Excerpt or Description of Desired Display
Diablo 630, 1640, or 1650 printer	A C 12 340 none none Y C D UL1 Y	(Terminal and Printer Characteristics – Submenu A) LST: baud rate: LST: baud rate: 1200 port: LST: baud rate: 1200 port: 0EOH = 340Q Serial Printer Ready Signal Polarity: LOW Serial Printer Ready Signal: RTS (Pin 4) CP/M Configuration (Main Menu) (Default I/O Configuration – Submenu C) LST: = LST: = UL1: CP/M Configuration (Main Menu)
DECwriter LA-34 or LA-36 printer	A C 30 340 none none P Y C D LPT Y	(Terminal and Printer Characteristics – Submenu A) LST: baud rate: LST: baud rate: 300 port: LST: baud rate: 300 port: 0EOH = 340Q Serial Printer Ready Signal Polarity: LOW Serial Printer Ready Signal: RTS (Pin 4) Z89-11 LPT Selection: SERIAL CP/M Configuration (Main Menu) (Default I/O Configuration – Submenu C) LST: = LST: = LPT: CP/M Configuration (Main Menu)
Heath H-14 printer	A C 4 340 none none P Y C D LPT Y	(Terminal and Printer Characteristics – Submenu A) LST: baud rate: LST: baud rate: 4800 port: LST: baud rate: 4800 port: 0EOH = 340Q Serial Printer Ready Signal Polarity: LOW Serial Printer Ready Signal: RTS (Pin 4) Z89-11 LPT Selection: SERIAL CP/M Configuration (Main Menu) (Default I/O Configuration – Submenu C) LST: = LST: = LPT: CP/M Configuration (Main Menu)

Table 1-31
Printers with Z89-11 Interface
(continued on next page)

Your Printer	Keyboard Entries	Excerpt or Description of Desired Display
Texas Instruments TI-810 printer	A C 4 340 none none P Y C D LPT Y	(Terminal and Printer Characteristics – Submenu A) LST: baud rate: LST: baud rate: 4800 port: LST: baud rate: 4800 port: 0E0H = 340Q Serial Printer Ready Signal Polarity: LOW Serial Printer Ready Signal: RTS (Pin 4) Z89-11 LPT Selection: SERIAL CP/M Configuration (Main Menu) (Default I/O Configuration – Submenu C) LST: = LST: = LPT: CP/M Configuration (Main Menu)
Zenith or Heath Z-25 or H-25 printer	A C 4 340 M none P Y C D LPT Y	(Terminal and Printer Characteristics – Submenu A) LST: baud rate: LST: baud rate: 4800 port: LST: baud rate: 4800 port: 0E0H = 340Q Serial Printer Ready Signal Polarity: HIGH Serial Printer Ready Signal: RTS (Pin 4) Z89-11 LPT Selection: SERIAL CP/M Configuration (Main Menu) (Default I/O Configuration – Submenu C) LST: = LST: = LPT: CP/M Configuration (Main Menu)
Epson MX-80 serial printer	A C 4 340 M N P Y C D LPT Y	(Terminal and Printer Characteristics – Submenu A) LST: baud rate: LST: baud rate: 4800 port: LST: baud rate: 4800 port: 0E0H = 340Q Serial Printer Ready Signal Polarity: HIGH Serial Printer Ready Signal: DTR (Pin 20) Z89-11 LPT Selection: SERIAL CP/M Configuration (Main Menu) (Default I/O Configuration – Submenu C) LST: = LST: = LPT: CP/M Configuration (Main Menu)

Table 1-31

Printers with Z89-11 Interface
(continued on next page)

Your Printer	Keyboard Entries	Excerpt or Description of Desired Display
Epson MX-80 parallel printer	A none none Y C D LPT Y	(Terminal and Printer Characteristics – Submenu A) Parallel Printer Ready Signal Polarity: HIGH Z89-11 LPT Selection: PARALLEL CP/M Configuration (Main Menu) (Default I/O Configuration – Submenu C) LST: = LST: = LPT: CP/M Configuration (Main Menu)

Table 1-31

Printers with Z89-11 Interface
 (continued from preceding page)

5. If your primary drive group consists of 96 TPI drives, type the sequence of keyboard entries listed in Table 1-32. To the right of each entry is an excerpt or description of the part of the display that should appear immediately **after** you type the entry.

Keyboard Entries	Excerpt or Description of Desired Display
B	5.25 Inch Soft-Sectored Unit 0 Step Rate: 30ms Track Density: 48tpi 5.25 Inch Soft-Sectored Unit 1 Step Rate: 30ms Track Density: 48tpi 5.25 Inch Soft-Sectored Unit 2 Step Rate: 30ms Track Density: 48tpi
A	Soft-Sector Unit 0 Step Rate ?
6	Soft-Sector Unit 0 Step Rate ? 6
RETURN	Soft-Sector Unit 0 Track Density ?
96	Soft-Sector Unit 0 Track Density ? 96
RETURN	5.25 Inch Soft-Sectored Unit 0 Step Rate: 6ms Track Density: 96tpi
	5.25 Inch Soft-Sectored Unit 1 Step Rate: 30ms Track Density: 48tpi
	5.25 Inch Soft-Sectored Unit 2 Step Rate: 30ms Track Density: 48tpi
B	Soft-Sector Unit 1 Step Rate ?
6	Soft-Sector Unit 1 Step Rate ? 6
RETURN	Soft-Sector Unit 1 Track Density ?
96	Soft-Sector Unit 1 Track Density ? 96
RETURN	5.25 Inch Soft-Sectored Unit 0 Step Rate: 6ms Track Density: 96tpi
	5.25 Inch Soft-Sectored Unit 1 Step Rate: 6ms Track Density: 96tpi
	5.25 Inch Soft-Sectored Unit 2 Step Rate: 30ms Track Density: 48tpi
C	Soft-Sector Unit 2 Step Rate ?
6	Soft-Sector Unit 2 Step Rate ? 6
RETURN	Soft-Sector Unit 2 Track Density ?
96	Soft-Sector Unit 2 Track Density ? 96
RETURN	5.25 Inch Soft-Sectored Unit 0 Step Rate: 6ms Track Density: 96tpi
	5.25 Inch Soft-Sectored Unit 1 Step Rate: 6ms Track Density: 96tpi
	5.25 Inch Soft-Sectored Unit 2 Step Rate: 6ms Track Density: 96tpi
Y	CP/M Configuration (Main Menu)

Table 1-32
CONFIGUR Entries for Primary 96 TPI Drives

If your primary drive group consists of 48 TPI 5.25-inch drives or 8-inch drives, then proceed to Step 6.

6. If your secondary drive group consists of any 96 TPI drives, type the sequence of keyboard entries listed in Table 1-33. To the right of each entry is an excerpt or description of the part of the display that should appear immediately **after** you type the entry.

Keyboard Entries	Excerpt or Description of Desired Display
B A 6 RETURN 96 RETURN	5.25 Inch Soft-Sectored Unit 0 Step Rate: 30ms Track Density: 48tpi 5.25 Inch Soft-Sectored Unit 1 Step Rate: 30ms Track Density: 48tpi 5.25 Inch Soft-Sectored Unit 2 Step Rate: 30ms Track Density: 48tpi Soft-Sector Unit 0 Step Rate ? Soft-Sector Unit 0 Step Rate ? 6 Soft-Sector Unit 0 Track Density ? Soft-Sector Unit 0 Track Density ? 96
B 6 RETURN 96 RETURN	5.25 Inch Soft-Sectored Unit 0 Step Rate: 6ms Track Density: 96tpi 5.25 Inch Soft-Sectored Unit 1 Step Rate: 30ms Track Density: 48tpi 5.25 Inch Soft-Sectored Unit 2 Step Rate: 30ms Track Density: 48tpi Soft-Sector Unit 1 Step Rate ? Soft-Sector Unit 1 Step Rate ? 6 Soft-Sector Unit 1 Track Density ? Soft-Sector Unit 1 Track Density ? 96
C 6 RETURN 96 RETURN	5.25 Inch Soft-Sectored Unit 0 Step Rate: 6ms Track Density: 96tpi 5.25 Inch Soft-Sectored Unit 1 Step Rate: 6ms Track Density: 96tpi 5.25 Inch Soft-Sectored Unit 2 Step Rate: 30ms Track Density: 48tpi Soft-Sector Unit 2 Step Rate ? Soft-Sector Unit 2 Step Rate ? 6 Soft-Sector Unit 2 Track Density ? Soft-Sector Unit 2 Track Density ? 96
Y	5.25 Inch Soft-Sectored Unit 1 Step Rate: 6ms Track Density: 96tpi CP/M Configuration (Main Menu)

Table 1-33
CONFIGUR Entries for Secondary 96 TPI Drives

If your secondary drive group does not consist of any 96 TPI drives, then proceed to step 7.

7. CONFIGUR should now display the selection menu labelled "CP/M Configuration". Respond to the selection prompt in this menu by typing **Y**. CP/M will display the "A>" system prompt.

You have just completed your customization procedure. If you correctly followed your entire customization procedure, your System Disk should contain a copy of the CP/M Operating System that controls all components of your hardware environment.

To combine this customized operating system with an application program, proceed to the "Working Disk Procedures".

NOTE: If you have any hardware devices that are **not** listed in these tables and are still not working with your System Disk, then use the instructions in Volume II: Reference Guide to perform the CONFIGUR activity.

If you have devices that are listed in these tables and they still don't function properly with your System Disk, then the devices themselves might have been set with characteristics that this text could not anticipate. Therefore you should refer to your hardware manual(s) for hardware settings instructions, and to Volume II: The CP/M Reference Guide for CONFIGUR instructions.

Customizing Procedure Six

An H/Z67 (Winchester Disk) Drive and Some Secondary Drives

OR

One 96 TPI, 5.25-Inch and One or Two 48 TPI, 5.25-Inch Primary Drives and Some Secondary Drives

This procedure will help you to customize the copy of the CP/M Operating System that resides on your Backup Partition or Disk. If you have a Backup Partition, this procedure will refer to it as a "System Partition". If you have a Backup Disk, this procedure will refer to it as a "System Disk".

If you have an H/Z-67, then write-protect switch 0 should be pressed down to write enable the Winchester Disk.

PROCEDURE SYNOPSIS

This procedure requires you to perform the following activities in sequence:

```
bootup
CONFIGUR
MAKEBIOS
MOVCPM*
SYSGEN
bootup
CONFIGUR
```

If you have a System Partition, begin Customizing Procedure Six by booting up with the System Partition. When the CONFIGUR utility is automatically invoked, wait for the "Standard system" prompt and type Y. Then proceed to the MAKEBIOS activity.

If you have a System Disk, begin Customizing Procedure Six by inserting the System Disk in the 96 TPI drive and booting up with the System Disk. When the CONFIGUR utility is automatically invoked, wait for the "Standard system" prompt and type Y. Then proceed to the CONFIGUR activity.

* Use either MOVCPM67 or MOVCPM37.

CONFIGUR

This CONFIGUR activity enables you to record software on the 96 TPI System Disk.

1. When the CONFIGUR activity is automatically invoked, it will display several messages. Wait for CONFIGUR to display the following message:

```
STANDARD SYSTEM (Y OR N)? <Y>:
```

2. Type **N** at the "STANDARD SYSTEM" prompt. CONFIGUR will display the "CP/M CONFIGURATION" menu.
3. Type **B** at the "SELECTION" prompt beneath the "CP/M CONFIGURATION" menu. CONFIGUR will display The disk parameters menu (submenu B), showing the status of your 5.25-inch drive units.
4. Select the "SOFT-SECTORED UNIT" that corresponds to your 96 TPI primary drive. CONFIGUR will prompt you to enter a "STEP RATE".
5. Type **6** and **RETURN** for the step rate of your 96 TPI primary drive. (This entry is necessary to change the 30 ms default step rate.) CONFIGUR will prompt you to enter a "TRACK DENSITY".
6. Type **96** and **RETURN** for the track density of your 96 TPI primary drive. (This entry is necessary to change the 48 TPI default track density.) CONFIGUR will display the changed status of your 96 TPI drive.
7. Type **Y** at the "SELECTION" prompt beneath the drive disk parameters menu (submenu B). CONFIGUR will redisplay the "CP/M CONFIGURATION" menu.
8. Type **Y** at the "SELECTION" prompt beneath the "CP/M CONFIGURATION" menu. CP/M will display the system prompt.

Proceed to the MAKEBIOS activity.

MAKEBIOS

The MAKEBIOS utility helps you to modify the CP/M Operating System so that it can control the disk drives in your secondary drive group.

1. At the A> system prompt, type the following command line to run MAKEBIOS:

A>**SUBMIT MAKEBIOS A: RETURN**

The MAKEBIOS utility will display the following:

A>MAKEBIOS 1 A:

BIOS SELECTION MENU

A -- H17 ONLY
B -- H37 ONLY
C -- H47 ONLY
D -- H67 ONLY
E -- H17 AND H37
F -- H17 AND H47
G -- H17 AND H67
H -- H37 AND H47
I -- H37 AND H67
J -- H47 AND H67

ENTER SELECTION:

2. At the "ENTER SELECTION" prompt, type a selection letter according to the following criteria:
 - If you have both 5.25-inch hard-sectored drives and 5.25-inch soft-sectored drives, then type **E RETURN**.
 - If you have both 5.25-inch hard-sectored drives and H/Z-67 drives, then type **G RETURN**.
 - If you have both 5.25-inch soft-sectored drives and 8-inch H/Z-47 drives, then type **H RETURN**.
 - If you have both 5.25-inch soft-sectored drives and H/Z-67 drives, then type **I RETURN**.
 - If you have both 8-inch H/Z-47 drives and H/Z-67 drives, then type **J RETURN**.

After you type in one of these selection letters and a carriage return, your terminal display will show seven command lines and other messages, ending with the message:

```
MAKEBIOS FUNCTION COMPLETE
```

```
A>
```

Proceed to the MOVCPM activity.

MOVCPM

The MOVCPM utility puts a copy of the operating system into a special location in computer memory, where the system is automatically modified. The MOVCPM activity must be followed by the SYSGEN activity.

1. If you have a System Partition, type **MOVCPM67 * A: RETURN.**

If you have a System Disk, type **MOVCPM37 * A: RETURN.**

2. Wait till your MOVCPM utility displays a message in the following form:

```
MOVCPMxx Version 2.2.04  
CONSTRUCTING nnk CP/M vers 2.2  
READY FOR "SYSGEN" OR  
"SAVE 38 CPMnn.COM"
```

A>

Proceed immediately to the SYSGEN activity.

SYSGEN

The SYSGEN utility puts a partially customized copy of the CP/M Operating System on the System Partition or System Disk. SYSGEN will get this operating system copy from a special location in computer memory. (A MOVCPM activity put the operating system into this special memory location.)

1. At the A> prompt, type **SYSGEN** and press **RETURN**. This entry invokes the SYSGEN utility, which displays a message in the form:

```
SYSGEN VERSION 2.0.04  
SOURCE DRIVE NAME (OR RETURN TO SKIP):
```

2. Press **RETURN**. SYSGEN will display:

```
DESTINATION DRIVE NAME (OR RETURN TO REBOOT):
```

3. Type **A**. SYSGEN will display:

```
DESTINATION ON A, THEN TYPE RETURN
```

4. Press **RETURN**. SYSGEN will display:

```
FUNCTION COMPLETE  
DESTINATION DRIVE NAME (OR RETURN TO REBOOT):
```

5. Reset the computer by holding down the **SHIFT** key and pressing the **RESET** key. Do not enter a carriage return at this prompt.
6. Boot up with the System Partition or with the System Disk in the 96 TPI drive.

Proceed to the CONFIGUR activity.

CONFIGUR

The CONFIGUR utility customizes the operating system on your System Partition or System Disk to match several characteristics of your hardware environment. This procedure will show you how to use CONFIGUR to customize the system for essential hardware characteristics. (Use the CONFIGUR instructions in the Volume II: The CP/M Reference Guide if you want more detailed instructions on using CONFIGUR.)

1. Type the command **CONFIGUR RETURN** at the system prompt. This entry invokes CONFIGUR, which will present a display that begins with an identification message in the following form:

```
Heath/Zenith Configuration Program
Version 2.2.04
Serial Number: sss-sssss
```

CONFIGUR will continue to display messages, ending with the following prompt:

```
Standard system (Y or N)? <Y>:
```

2. Type **N**. CONFIGUR will display a selection menu labelled "CP/M Configuration".
3. Refer to Table 1-34 if you have a Z89-3 interface card, and to Table 1-35 if you have a Z89-11 interface card. Using the appropriate table, type the keyboard entries listed for your terminal. To the right of each entry is an excerpt or description of part of the display that should appear immediately **after** you type the entry. If the excerpted or described display in the table does not appear on your terminal, repeat the entry.

NOTE: Type only the capital letters or numbers featured in bold faced type beneath the heading "Keyboard Entries". Do not change the order of the entries listed. If you type an incorrect entry at a prompt, CONFIGUR will either ignore your mistake, or display it. If a mistake is ignored, simply answer the prompt again. If CONFIGUR displays your mistake, you can usually change it by typing **Z** and repeating a few entries.

Your Terminal	Keyboard Entries	Excerpt or Description of Desired Display
Zenith or Heath Z-19, H-19, Z-88, H-88, Z-89, H-89, or Z-90 terminal	A A 9 350 Y C A CRT Y	(Terminal and Printer Characteristics – Submenu A) CRT: baud rate: CRT: baud rate: 9600 port: CRT: baud rate: 9600 port: 0E8H = 350Q CP/M Configuration (Main Menu) (Default I/O Configuration – Submenu C) CRT: = CON: = CRT: CP/M Configuration (Main Menu)
DECwriter LA-34 or LA-36 terminal	A B 30 320 Y C A TTY Y	(Terminal and Printer Characteristics – Submenu A) TTY: baud rate: TTY: baud rate: 300 port: TTY: baud rate: 300 port: 0D0H = 320Q CP/M Configuration (Main Menu) (Default I/O Configuration – Submenu C) CON: = CON: = TTY: CP/M Configuration (Main Menu)
Diablo KSR 1640 terminal	A B 12 320 Y C A TTY Y	(Terminal and Printer Characteristics – Submenu A) TTY: baud rate: TTY: baud rate: 1200 port: TTY: baud rate: 1200 port: 0D0H = 320Q CP/M Configuration (Main Menu) (Default I/O Configuration – Submenu C) CON: = CON: = TTY: CP/M Configuration (Main Menu)

Table 1-34
Terminals with Z89-3 Interface

Your Terminal	Keyboard Entries	Excerpt or Description of Desired Display
Zenith or Heath Z-19, H-19, Z-88, H-88, Z-89, H-89, or Z-90 terminal	A A 9 350 Y C A CRT Y	(Terminal and Printer Characteristics – Submenu A) CRT: baud rate: CRT: baud rate: 9600 port: CRT: baud rate: 9600 port: 0E8H = 350Q CP/M Configuration (Main Menu) (Default I/O Configuration – Submenu C) CRT: = CON: = CRT: CP/M Configuration (Main Menu)
DECwriter LA-34 or LA-36 terminal	A B 30 330 Y C A TTY Y	(Terminal and Printer Characteristics – Submenu A) TTY: baud rate: TTY: baud rate: 300 port: TTY: baud rate: 300 port: 0D8H = 330Q CP/M Configuration (Main Menu) (Default I/O Configuration – Submenu C) CON: = CON: = TTY: CP/M Configuration (Main Menu)
Diablo KSR 1640 terminal	A B 12 330 Y C A TTY Y	(Terminal and Printer Characteristics – Submenu A) TTY: baud rate: TTY: baud rate: 1200 port: TTY: baud rate: 1200 port: 0D8H = 330Q CP/M Configuration (Main Menu) (Default I/O Configuration – Submenu C) CON: = CON: = TTY: CP/M Configuration (Main Menu)

Table 1-35

Terminals with Z89-11 Interface

- Refer to Table 1-36 if you have a Z89-3 interface card, and to Table 1-37 if you have a Z89-11 interface card. Using the appropriate table, type the keyboard entries listed for your printer. To the right of each entry is an excerpt or description of part of the display that should appear immediately **after** you type the entry. If the excerpted or described display in the table does not appear, repeat the entry.

Your Printer	Keyboard Entries	Excerpt or Description of Desired Display
Diablo 630, 1640, or 1650 printer	A C 12 340 none none Y C D UL1 Y	(Terminal and Printer Characteristics – Submenu A) LST: baud rate: LST: baud rate: 1200 port: LST: baud rate: 1200 port: 0E0H = 340Q Serial Printer Ready Signal Polarity: LOW Serial Printer Ready Signal: RTS (Pin 4) CP/M Configuration (Main Menu) (Default I/O Configuration – Submenu C) LST: = LST: = UL1: CP/M Configuration (Main Menu)
DECwriter LA-34 or LA-36 printer	A C 30 340 none none Y C D LPT Y	(Terminal and Printer Characteristics – Submenu A) LST: baud rate: LST: baud rate: 300 port: LST: baud rate: 300 port: 0E0H = 340Q Serial Printer Ready Signal Polarity: LOW Serial Printer Ready Signal: RTS (Pin 4) CP/M Configuration (Main Menu) (Default I/O Configuration – Submenu C) LST: = LST: = LPT: CP/M Configuration (Main Menu)
Heath H-14 printer	A C 4 340 none none Y C D LPT Y	(Terminal and Printer Characteristics – Submenu A) LST: baud rate: LST: baud rate: 4800 port: LST: baud rate: 4800 port: 0E0H = 340Q Serial Printer Ready Signal Polarity: LOW Serial Printer Ready Signal: RTS (Pin 4) CP/M Configuration (Main Menu) (Default I/O Configuration – Submenu C) LST: = LST: = LPT: CP/M Configuration (Main Menu)

Table 1-36

Printers with Z89-3 Interface
(continued on next page)

Keyboard Your Printer	Entries	Excerpt or Description of Desired Display
Texas Instruments TI-810 printer	A C 4 340 none none Y C D LPT Y	(Terminal and Printer Characteristics – Submenu A) LST: baud rate: LST: baud rate: 4800 port: LST: baud rate: 4800 port: 0E0H = 340Q Serial Printer Ready Signal Polarity: LOW Serial Printer Ready Signal: RTS (Pin 4) CP/M Configuration (Main Menu) (Default I/O Configuration – Submenu C) LST: = LST: = LPT: CP/M Configuration (Main Menu)
Zenith or Heath Z-25 or H-25 printer	A C 4 340 M none Y C D LPT Y	(Terminal and Printer Characteristics – Submenu A) LST: baud rate: LST: baud rate: 4800 port: LST: baud rate: 4800 port: 0E0H = 340Q Serial Printer Ready Signal Polarity: HIGH Serial Printer Ready Signal: RTS (Pin 4) CP/M Configuration (Main Menu) (Default I/O Configuration – Submenu C) LST: = LST: = LPT: CP/M Configuration (Main Menu)
Epson MX-80 serial printer	A C 4 340 M N Y C D LPT Y	(Terminal and Printer Characteristics – Submenu A) LST: baud rate: LST: baud rate: 4800 port: LST: baud rate: 4800 port: 0E0H = 340Q Serial Printer Ready Signal Polarity: HIGH Serial Printer Ready Signal: DTR (Pin 20) CP/M Configuration (Main Menu) (Default I/O Configuration – Submenu C) LST: = LST: = LPT: CP/M Configuration (Main Menu)

Table 1-36
Printers with Z-89-3 Interface
(continued from preceding page)

Your Printer	Keyboard Entries	Excerpt or Description of Desired Display
Diablo 630, 1640, or 1650 printer	A C 12 340 none none Y C D UL1 Y	(Terminal and Printer Characteristics – Submenu A) LST: baud rate: LST: baud rate: 1200 port: LST: baud rate: 1200 port: 0E0H = 340Q Serial Printer Ready Signal Polarity: LOW Serial Printer Ready Signal: RTS (Pin 4) CP/M Configuration (Main Menu) (Default I/O Configuration – Submenu C) LST: = LST: = UL1: CP/M Configuration (Main Menu)
DECwriter LA-34 or LA-36 printer	A C 30 340 none none P Y C D LPT Y	(Terminal and Printer Characteristics – Submenu A) LST: baud rate: LST: baud rate: 300 port: LST: baud rate: 300 port: 0E0H = 340Q Serial Printer Ready Signal Polarity: LOW Serial Printer Ready Signal: RTS (Pin 4) Z89-11 LPT Selection: SERIAL CP/M Configuration (Main Menu) (Default I/O Configuration – Submenu C) LST: = LST: = LPT: CP/M Configuration (Main Menu)
Heath H-14 printer	A C 4 340 none none P Y C D LPT Y	(Terminal and Printer Characteristics – Submenu A) LST: baud rate: LST: baud rate: 4800 port: LST: baud rate: 4800 port: 0E0H = 340Q Serial Printer Ready Signal Polarity: LOW Serial Printer Ready Signal: RTS (Pin 4) Z89-11 LPT Selection: SERIAL CP/M Configuration (Main Menu) (Default I/O Configuration – Submenu C) LST: = LST: = LPT: CP/M Configuration (Main Menu)

Table 1-37

Printers with Z89-11 Interface
(continued on following page)

Your Printer	Keyboard Entries	Excerpt or Description of Desired Display
Texas Instruments TI-810 printer	A C 4 340 none none P Y C D LPT Y	(Terminal and Printer Characteristics – Submenu A) LST: baud rate: LST: baud rate: 4800 port: LST: baud rate: 4800 port: OE0H = 340Q Serial Printer Ready Signal Polarity: LOW Serial Printer Ready Signal: RTS (Pin 4) Z89-11 LPT Selection: SERIAL CP/M Configuration (Main Menu) (Default I/O Configuration – Submenu C) LST: = LST: = LPT: CP/M Configuration (Main Menu)
Zenith or Heath Z-25 or H-25 printer	A C 4 340 M none P Y C D LPT Y	(Terminal and Printer Characteristics – Submenu A) LST: baud rate: LST: baud rate: 4800 port: LST: baud rate: 4800 port: OE0H = 340Q Serial Printer Ready Signal Polarity: HIGH Serial Printer Ready Signal: RTS (Pin 4) Z89-11 LPT Selection: SERIAL CP/M Configuration (Main Menu) (Default I/O Configuration – Submenu C) LST: = LST: = LPT: CP/M Configuration (Main Menu)
Epson MX-80 serial printer	A C 4 340 M N P Y C D LPT Y	(Terminal and Printer Characteristics – Submenu A) LST: baud rate: LST: baud rate: 4800 port: LST: baud rate: 4800 port: OE0H = 340Q Serial Printer Ready Signal Polarity: HIGH Serial Printer Ready Signal: DTR (Pin 20) Z89-11 LPT Selection: SERIAL CP/M Configuration (Main Menu) (Default I/O Configuration – Submenu C) LST: = LST: = LPT: CP/M Configuration (Main Menu)

Table 1-37

Printers with Z89-11 Interface
(continued on following page)

Your Printer	Keyboard Entries	Excerpt or Description of Desired Display
Epson MX-80 parallel printer	A none none Y C D LPT Y	(Terminal and Printer Characteristics – Submenu A) Parallel Printer Ready Signal Polarity: HIGH Z89-11 LPT Selection: PARALLEL CP/M Configuration (Main Menu) (Default I/O Configuration – Submenu C) LST: = LST: = LPT: CP/M Configuration (Main Menu)

Table 1-37

Printers with Z89-11 Interface
 (continued from preceding page)

5. CONFIGUR should now display the selection menu labelled “CP/M Configuration”.

If you have a System Partition (instead of a System Disk), then proceed to step 6.

If you have a System Disk (instead of a System Partition), then respond to the selection prompt beneath the “CP/M Configuration” menu by typing **B**. CONFIGUR will display the disk parameters menu (submenu B), showing the status of your 5.25-inch drive units. Skip ahead to step 7.

If your secondary drive group consists of any 96 TPI drives, type the sequence of keyboard entries listed in Table 1-38. To the right of each entry is an excerpt or description of the part of the display that should appear immediately **after** you type the entry.

Keyboard Entries	Excerpt or Description of Desired Display
B	5.25 Inch Soft-Sector Unit 0 Step Rate: 30ms Track Density: 48tpi 5.25 Inch Soft-Sector Unit 1 Step Rate: 30ms Track Density: 48tpi 5.25 Inch Soft-Sector Unit 2 Step Rate: 30ms Track Density: 48tpi
A	Soft-Sector Unit 0 Step Rate ?
6	Soft-Sector Unit 0 Step Rate ? 6
RETURN	Soft-Sector Unit 0 Track Density ?
96	Soft-Sector Unit 0 Track Density ? 96
RETURN	5.25 Inch Soft-Sector Unit 0 Step Rate: 6ms Track Density: 96tpi
	5.25 Inch Soft-Sector Unit 1 Step Rate: 30ms Track Density: 48tpi
	5.25 Inch Soft-Sector Unit 2 Step Rate: 30ms Track Density: 48tpi
B	Soft-Sector Unit 1 Step Rate ?
6	Soft-Sector Unit 1 Step Rate ? 6
RETURN	Soft-Sector Unit 1 Track Density ?
96	Soft-Sector Unit 1 Track Density ? 96
RETURN	5.25 Inch Soft-Sector Unit 0 Step Rate: 6ms Track Density: 96tpi
	5.25 Inch Soft-Sector Unit 1 Step Rate: 6ms Track Density: 96tpi
	5.25 Inch Soft-Sector Unit 2 Step Rate: 30ms Track Density: 48tpi
C	Soft-Sector Unit 2 Step Rate ?
6	Soft-Sector Unit 2 Step Rate ? 6
RETURN	Soft-Sector Unit 2 Track Density ?
96	Soft-Sector Unit 2 Track Density ? 96
RETURN	5.25 Inch Soft-Sector Unit 0 Step Rate: 6ms Track Density: 96tpi
	5.25 Inch Soft-Sector Unit 1 Step Rate: 6ms Track Density: 96tpi
	5.25 Inch Soft-Sector Unit 2 Step Rate: 6ms Track Density: 96tpi
Y	CP/M Configuration (Main Menu)

Table 1-38
CONFIGUR Entries for Secondary 96 TPI Drives

If your secondary drive group does not consist of any 96 TPI drives, then skip ahead to step 11.

7. Select the "Soft Sectoring Unit" that corresponds to your 96 TPI primary drive. CONFIGUR will prompt you to enter a "Step Rate".
8. Type **6** and **RETURN** for the step rate of your 96 TPI primary drive. (This entry is necessary to change the 30 ms default step rate.) CONFIGUR will prompt you to enter a "Track Density".
9. Type **96** and **RETURN** for the track density of your 96 TPI primary drive. (This entry is necessary to change the 48 TPI default track density). CONFIGUR will display the changed status of your 96 TPI drive.
10. Type **Y** at the "Selection" prompt beneath the drive disk parameters menu (submenu B). CONFIGUR will redisplay the "CP/M Configuration" menu.
11. Type **Y** at the "Selection" prompt beneath the "CP/M Configuration" menu. CP/M will display the system prompt.

You have just completed your customizing procedure. If you correctly followed your entire customizing procedure, your System Partition or System Disk should contain a copy of the CP/M Operating System that controls all components of your hardware environment.

To combine this customized operating system with an application program, proceed to the "Working Disk Procedures".

NOTE: If you have any hardware devices that are **not** listed in these tables, then use the instructions in Volume II: The CP/M Reference Guide to perform the CONFIGUR activity.

If you have devices that are listed in these tables and they still don't function properly with your System Partition or System Disk, then the devices themselves might have been set with characteristics that this text could not anticipate. Therefore you should refer to your hardware manual(s) for hardware settings instructions, and to Volume II: The CP/M Reference Guide for CONFIGUR instructions.

WORKING DISK PROCEDURES

After you have a fully customized copy of the CP/M Operating System on your System Disk (or System Partition), you will probably find it convenient to have your favorite application programs on this disk (or partition) as well.

A disk (or partition) containing both the CP/M Operating System and useful application programs is called a “Working Disk” (or “Working Partition”). Constructing a Working Disk (or Working Partition) involves a quick procedure through which you transfer copies of application programs to your System Disk (or System Partition) by using the PIP utility. Thus, your System Disk (or System Partition) becomes a Working Disk (or Working Partition).

The working disk procedure you use is determined by the kind of drive you used to boot up. You booted up using a drive slot from your primary drive group. Find the description of your primary drive group on the left side of Table 1-45. The working disk procedure listed to the right of this description is the procedure you should use to create a working disk (or working partition).

PRIMARY DRIVE GROUP DESCRIPTION	PROPER WORKING DISK PROCEDURE	PAGE
One 48 TPI, 5.25-inch drive	Working Disk Procedure One	1-237
One 96 TPI, 5.25-inch drive	Working Disk Procedure One	1-237
Two 48 TPI, 5.25-inch drives	Working Disk Procedure Two	1-238
Three 48 TPI, 5.25-inch drives	Working Disk Procedure Three	1-239
Two 48 TPI, 8-inch drives (H-47 or Z-47)	Working Disk Procedure Four	1-240
Two 96 TPI, 5.25-inch drives	Working Disk Procedure Two	1-238
Two 96 TPI, 5.25-inch drives and one 48 TPI, 5.25-inch drive	Working Disk Procedure Three	1-239
Three 96 TPI, 5.25-inch drives	Working Disk Procedure Three	1-239
One Winchester/floppy drive (H-67 or Z-67)	Working Disk Procedure Five	1-241
One 96 TPI, 5.25-inch drive and one 48 TPI, 5.25-inch drive	Working Disk Procedure Six	1-242
One 96 TPI, 5.25-inch drive and two 48 TPI, 5.25-inch drives	Working Disk Procedure Six	1-242

Table 1-45
Working Disk Procedures

This procedural section also includes a text concerning "System Copying Between Unlike Disks", for users who have the hardware and the desire necessary to copy the CP/M Operating System to disks within secondary drives.

Working Disk Procedure One

One Primary 5.25-Inch Drive

This procedure will help you to copy application programs from an Application Program Disk to your System Disk using a utility from the Backup Disk (or Backup Disk I). The System Disk must be write-enabled during this procedure.

1. Insert the Backup Disk (or Backup Disk I) in the drive slot, call the System Disk "DISK B", and call the Application Program Disk "DISK C".
2. Perform bootstrap.
3. Type **PIP RETURN** at the "A>" system prompt. This entry invokes PIP, which will display the "*" prompt.
4. Type **B:=C:{filename.ext} RETURN** at the "*" prompt; where {filename.ext} is the name of a file you wish to copy from the Application Program Disk to the System Disk. When finished copying the file, PIP will redisplay the "*" prompt.
5. Insert "DISK B" (System Disk), "DISK C" (Application Program Disk), and "DISK A" (Backup Disk) as prompted.
6. For each application program you wish to copy from the same Application Program Disk, repeat Steps 4 and 5.

For each application program you wish to copy from a different Application Program disk, press **RETURN** at the "*" prompt and repeat Steps 3, 4, and 5.

Your former System Disk is now a Working Disk, containing a fully customized CP/M Operating System and your favorite application programs. Use a felt-tipped pen to carefully modify the label. Then perform bootstrap with the Working Disk and invoke an application program.

Working Disk Procedure Two

Two Primary 5.25-inch Drives of the Same Type

This procedure will help you to copy application programs from an Application Program Disk to your System Disk using a utility from the Backup Disk (or Backup Disk I). The System Disk must be write-enabled during this procedure.

1. Insert the Backup Disk (or Backup Disk I) in drive A:, insert the System Disk in drive B:, and call the Application Program Disk "DISK C".
2. Perform bootstrap.
3. Type **PIP RETURN** at the "A>" system prompt. This entry invokes PIP, which will display the "*" prompt.
4. Type **B:=C:{filename.ext} RETURN** at the "*" prompt; where {filename.ext} is the name of a file you wish to copy from the Application Program Disk to the System Disk. When finished copying the file, PIP will redisplay the "*" prompt.
5. Insert "DISK B" (System Disk), "DISK C" (Application Program Disk), and "DISK A" (Backup Disk) as prompted.
6. For each application program you wish to copy from the same Application Program Disk, repeat Steps 4 and 5.

For each application program you wish to copy from a different Application Program disk, press **RETURN** at the "*" prompt and repeat Steps 3, 4, and 5.

Your former System Disk is now a Working Disk, containing a fully customized CP/M Operating System and your favorite application programs. Use a felt-tipped pen to carefully modify the label. Then perform bootstrap with the Working Disk and invoke an application program.

Working Disk Procedure Three

Three Primary 5.25-inch Drives

This procedure will help you to copy application programs from an Application Program Disk to your System Disk using a utility from the Backup Disk (or Backup Disk I). The System Disk must be write-enabled during this procedure.

1. Insert the System Disk in drive A:, insert the Backup Disk (or Backup Disk I) in drive B:, and insert the Application Program Disk in drive C:.
2. Perform bootstrap.
3. Type **B:PIP RETURN** at the "A>" system prompt. This entry invokes PIP, which will display the "*" prompt.
4. Type **A:=C:{filename.ext} RETURN** at the "*" prompt; where {filename.ext} is the name of a file you wish to copy from the Application Program Disk to the System Disk. When finished copying the file, PIP will redisplay the "*" prompt.
5. For each application program you wish to copy from the same Application Program Disk, repeat Step 4.

For each application program you wish to copy from a different Application Program Disk, press **RETURN** at the "*" prompt and repeat Steps 3 and 4.

Your former System Disk is now a Working Disk, containing a fully customized CP/M Operating System and your favorite application programs. Use a felt-tipped pen to carefully modify the label. Then perform bootstrap with the Working Disk and invoke an application program.

Working Disk Procedure Four

Two Primary 8-inch Drives

This procedure will help you to copy application programs from an Application Program Disk to your System Disk using a utility from the Backup Disk (or Backup Disk I). The System Disk must be write-enabled during this procedure.

1. Insert the Backup Disk (or Backup Disk I) in drive A: and insert the System Disk in drive B:.
2. Perform bootstrap.
3. Type **PIP RETURN** at the "A>" system prompt. This entry invokes PIP, which will display the "*" prompt.
4. Remove the Backup Disk from drive A:, and insert the Application Program disk in drive A:.
5. Type **B:=A:{filename.ext} RETURN** at the "*" prompt; where {filename.ext} is the name of a file you wish to copy from the Application Program Disk to the System Disk. When finished copying the file, PIP will redisplay the "*" prompt.
6. For each application program you wish to copy from the same Application Program Disk, repeat Steps 4 and 5.

For each application program you wish to copy from a different Application Program Disk, press **RETURN** at the "*" prompt and repeat Steps 3, 4, and 5.

Your former System Disk is now a Working Disk, containing a fully customized CP/M Operating System and your favorite application programs. Use a felt-tipped pen to carefully modify the label. Then perform bootstrap with the Working Disk and invoke an application program.

Working Disk Procedure Five

One Winchester/Floppy Drive

This procedure will help you to copy application programs from an Application Program Disk to your System Partition. The System Partition must be write-enabled during this procedure.

1. Insert the Application Program Disk in the floppy disk drive slot of the H/Z67 drive model. This slot is drive C:.
2. Perform bootstrap with the System Partition.
3. Type **PIP RETURN** at the "A>" system prompt. This entry invokes PIP, which will display the "*" prompt.
4. Type **A: = C:{filename.ext} RETURN** at the "*" prompt; where {filename.ext} is the name of a file you wish to copy from the Application Program Disk to the System Partition. When finished copying the file, PIP will redisplay the "*" prompt.
5. For each application program you wish to copy from the same Application Program Disk, repeat Step 4.

For each application program you wish to copy from a different Application Program Disk, press **RETURN** at the "*" prompt and repeat Steps 3 and 4.

Your former System Partition is now a Working Partition, containing a fully customized CP/M Operating System and your favorite application programs. Perform bootstrap with the Working Disk and invoke an application program.

Working Disk Procedure Six

One 96 TPI, 5.25-Inch Primary Drive and One or Two 48 TPI, 5.25-Inch Primary Drive(s)

This procedure will help you to copy application programs from an Application Program Disk to your System Disk. The System Disk must be write-enabled during this procedure.

1. Insert the System Disk in the 96 TPI drive and the Application Program Disk in the floppy disk in a 48 TPI drive.
2. Boot up with the System Disk.
3. Type **PIP RETURN** at the "A>" system prompt. This entry invokes PIP, which will display the "*" prompt.
4. Type a command in the following form at the "*" prompt:

***A:=x:{filename.ext}[V] RETURN**

Where **A** is the drive letter that references the System Disk in the 96 TPI drive;

where **x** stands for the drive letter that references the Application Program Disk in the 48 TPI drive;

where **{filename.ext}** stands for the name of a file that you wish to copy from the Application Program Disk to the System Disk; and

where **[V]** is an option that verifies the accuracy of this PIP activity.

After copying the file, PIP will redisplay the "*" prompt.

5. For each application program you wish to copy from the same Application Program Disk, repeat Step 4.

For each application program you wish to copy from a different Application Program Disk, press **RETURN** at the "*" prompt and repeat Steps 3 and 4.

Your former System Disk is now a Working Disk, containing a fully customized CP/M Operating System and your favorite application programs. Boot up with the Working Disk and invoke an application program.

System Copying Between Unlike Disks

This page provides a general procedure for any user who wishes to copy the CP/M Operating System between two **different** types of disk media. To copy the system between unlike media, you should use MOVCPMxx, SYSGEN, and PIP utilities in sequence.

Furthermore, you should perform bootstrap with a fully customized System Disk or Working Disk, and enter commands that refer to the names of the disk drives containing the necessary utilities.

1. Run a MOVCPMxx utility that is compatible with the type of disk that is receiving the system, as explained below:
 - If the disk receiving the system copy is a hard sectored 5.25-inch disk being used in a Z89, H89, Z87, H77, or H17, then use **MOVCPM17**.
 - If the disk receiving the system copy is a soft sectored 5.25-inch disk being used in a Z90, Z89, H89, Z87, H77, Z37, or H17, then use **MOVCPM37**.
 - If the disk receiving the system copy is an 8-inch disk that will be used in a Z47 or H47 disk drive model, then use **MOVCPM47**.
 - If the media receiving the system copy is either a Winchester disk partition or an 8-inch disk used in a Z67 disk drive model, then use **MOVCPM67**.
2. Run the SYSGEN utility immediately after the MOVCPMxx utility:
 - Press **RETURN** when SYSGEN displays the "SOURCE DRIVE NAME (OR RETURN TO SKIP):" prompt.
 - Type a drive letter at the "DESTINATION DRIVE NAME" prompt.
 - Press **RETURN** to confirm your selection for "DESTINATION".
 - When SYSGEN displays the second "DESTINATION DRIVE NAME" prompt, you can select another drive letter to copy the system to another disk, or you can press **RETURN** to exit from the SYSGEN utility.

3. Run PIP to copy the file BIOS.SYS to the destination disk.

- Type a command in the form **PIP B:=A:BIOS.SYS[RV]**
RETURN.
- In this command, drive A contains the System Disk or Working Disk (with the customized BIOS.SYS file and the PIP.COM utility file), and drive B contains the disk receiving the file copy.
- Press **CTRL-C** to perform a warm boot.
- Repeat the PIP command for each destination disk.

NOTE: If your CP/M backup software consists of three 5.25-inch disks, then the MOVCPMxx utilities you use in this procedure are stored on CP/M (Backup or Distribution) Disk II. The SYSGEN and PIP utilities are stored on CP/M (Backup or Distribution) disk I. Enter your commands using the appropriate drive specifications, and inserting disks as prompted.

